

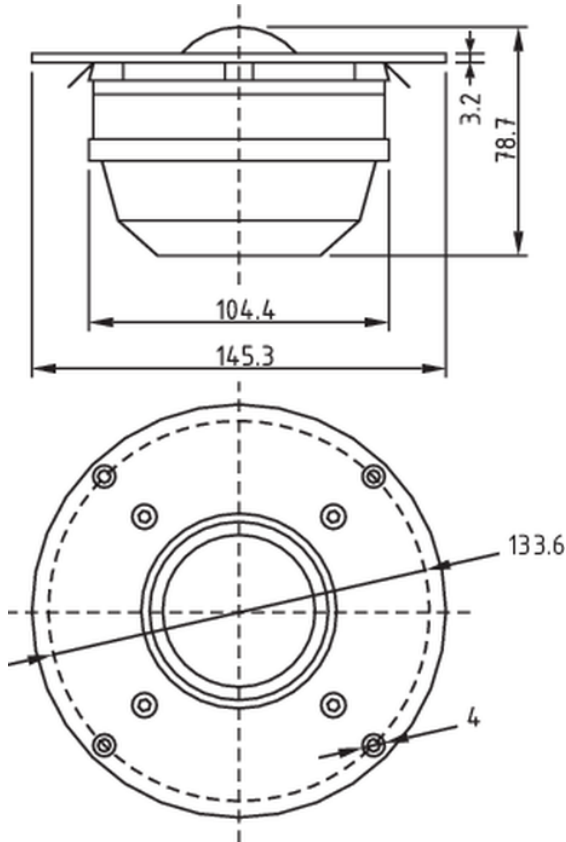

DC50FA-8 Classic Series 2" Dome Midrange 8 Ohm

DC50FA-8



PARAMETERS

Impedance	8 ohms
Re	4.4 ohms
Le	0.18 mH @ 10 kHz
Fs	371 Hz
Qms	4.13
Qes	1.16
Qts	0.91
Mms	2.2g
Cms	0.07 mm/N
Sd	23.7 cm ²
Vd	N/A
BL	4.45 Tm
Vas	N/A
Xmax	1 mm
VC Diameter	52 mm
SPL	89 dB @ 2.83V/1m
RMS Power Handling	80 watts
Usable Frequency Range (Hz)	500 - 9,100 Hz

FEATURES

- Lower moving mass and superior off-axis frequency response
- Updated design used in many excellent DIY speaker systems
- New faceplate with four mounting holes

IMPEDANCE/PHASE



FREQUENCY RESPONSE

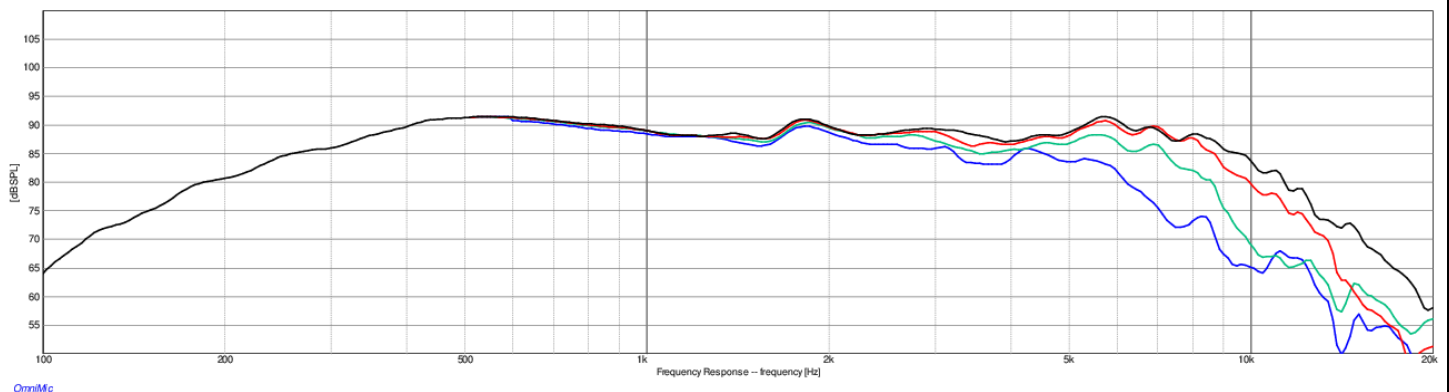

Note: 1/24th octave smoothing - nearfield response included in graph below 450 Hz.

Black = 0°
Red = 15°
Green = 30°
Blue = 45°