

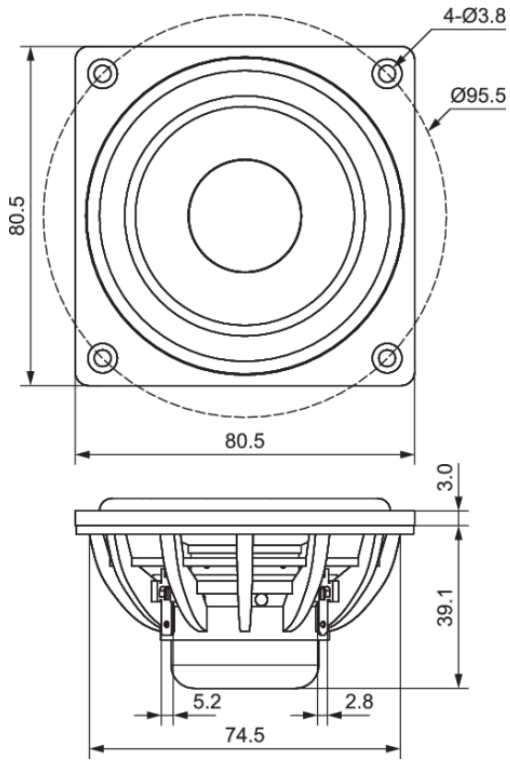

# DMA80-8 3" Dual Magnet Aluminum Cone Full-Range Driver 8 Ohm



## PARAMETERS

Impedance	8 ohms
Re	7.5 ohms
Le	0.5 mH @ 1 kHz
Fs	97.6 Hz
Qms	2.06
Qes	0.61
Qts	0.47
Mms	2.70 g
Cms	0.98 mm/N
Sd	31.2 cm <sup>2</sup>
Vd	7.8 cm <sup>3</sup>
BL	5.1 Tm
Vas	0.04 ft <sup>3</sup>
Xmax	2.5 mm
VC Diameter	1"
SPL	85.3 dB @ 2.83V/1m
RMS Power Handling	25 watts
Usable Frequency Range (Hz)	90-20,000 Hz

## FEATURES

- Excellent high frequency response for true full-range applications
- Dual neodymium motor to create a symmetrical magnetic field for superb control
- Large copper cap lowers distortion while improving high frequency response
- Vented aluminum voice coil former with exceptional heat dissipation for high power handling
- Exclusive 12-spoke open frame design provides extensive venting and minimal reflection
- DIY friendly, oversized mounting flange makes installation simple
- Matching tunable passive radiators also available!

## IMPEDANCE/PHASE

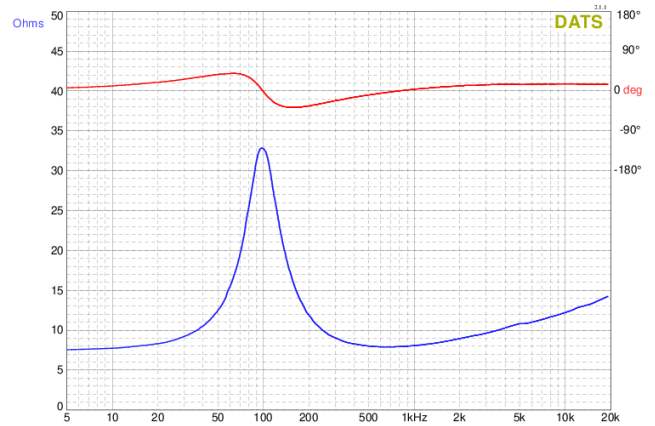

## FREQUENCY RESPONSE

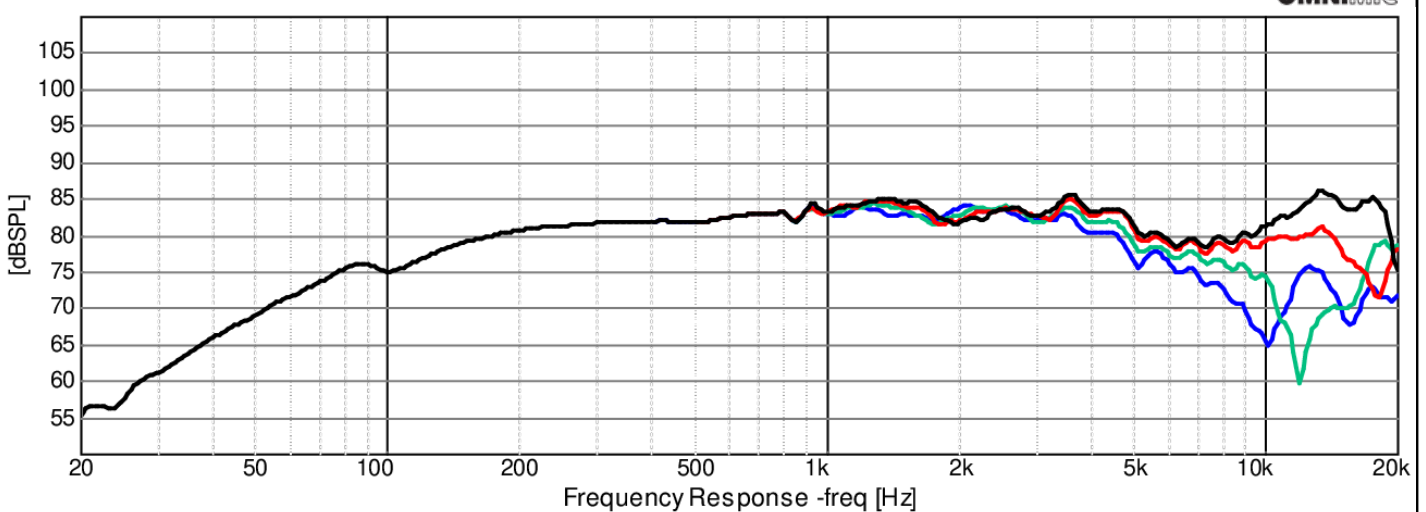

OmniMic

Note: 1/24<sup>th</sup> octave smoothing - nearfield response included in graph below 450 Hz.

Black = 0°  
Red = 15°  
Green = 30°  
Blue = 45°