



KPX User Guide

The Dayton Audio KPX Programmer is a multipurpose DSP programmer for the KAB series, KABD series, and future DSP amplifier boards from Dayton Audio. The programmer has two main programming modes – USBi mode is used for connecting KABD series amplifier boards to the Analog Devices SigmaStudio development tool, and the KABX mode is used for connecting compatible KAB amplifiers to the Dayton Audio KABX DSP tool.

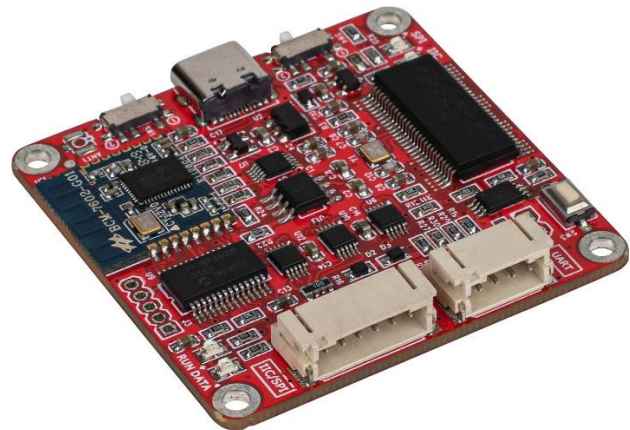
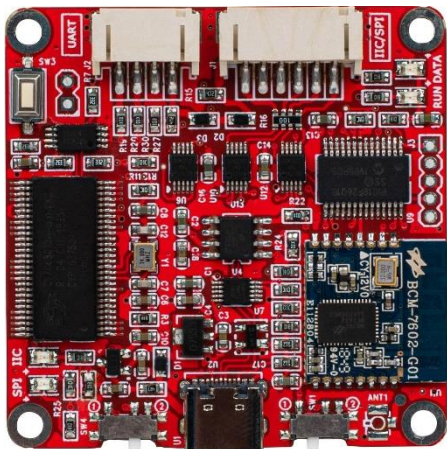
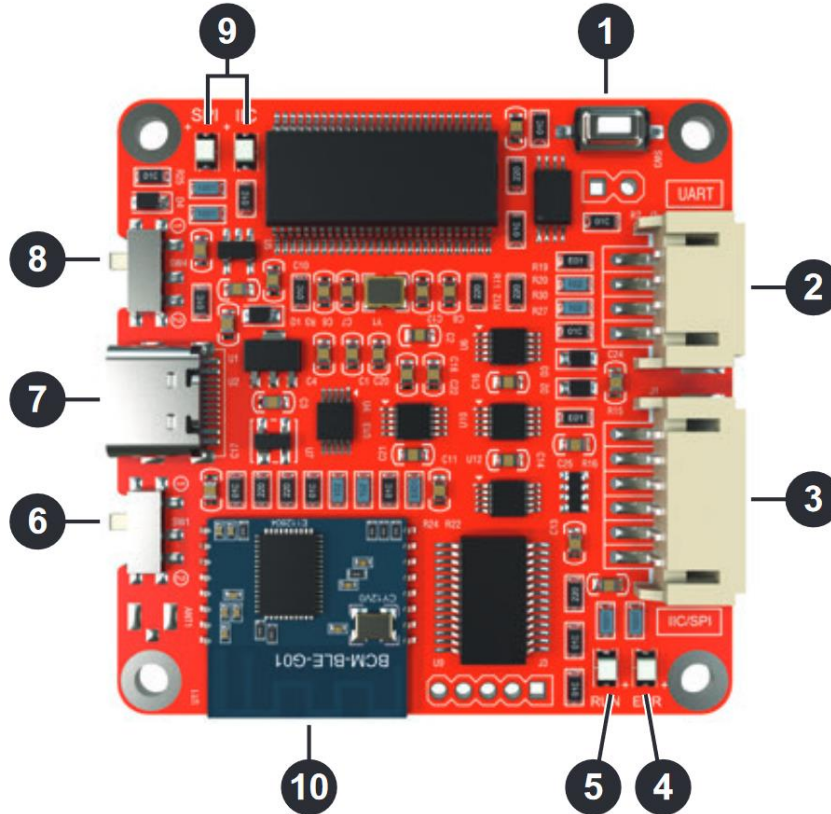

Table of Contents

Quick Reference Guide	2
What is the KPX for?	3
What Products are Compatible with the KPX Programmer?	3
Programming Dayton Audio Amplifier Boards with the KPX Programmer	4
Required Items for Programming	4
KPX Connection for KABX Programming (KABX Mode)	5
SigmaStudio Programming using the KPX Programmer (USBi Mode)	7
Upgrading your KPX Programmer	9
Additional Documents	10

Quick Reference Guide

1. SW3 Boot Loader Button (Service Only)
2. J2 – Connection to Dayton Audio KABX Controlled Products
3. J1 – Connection to SigmaStudio Controlled Products
4. Error Status LED
5. Microcontroller Status LED
6. SW1 – Programming mode Switch
7. U1 - USB Type-C for PC Connection and 5V Power
8. SW4 - USBi Communication Mode Switch
9. USBi Communication Status LEDs
10. Bluetooth BLE (For Future Use)



SW1 Position	Programing MODE	FUNCTION	SUPPORTED DEVICES
(1)	USBi Sigma DSP Connection via J1	SigmaStudio Control (IIC or SPI)	DSPB-100, DSPB-250, DSPB-K, KABD-250, KABD-230, KABD-430, KABD-4100
(2)	Dayton Audio KABX Connection via J2	Dayton Audio ARM DSP UI (UART)	KAB-250v4, KAB-230v4, KAB-100Mv2

SW4 Position	USBi Communication Type	FUNCTION	SUPPORTED DEVICES
(1)	SPI	For devices with ADAU1452 Chips	Future Products
(2)	IIC	For devices with ADAU1701 Chips	DSPB-100, DSPB-250, DSPB-K, KABD-250, KABD-230, KABD-430, KABD-4100

What is the KPX for?

Dayton Audio has multiple series of DSP compatible amplifier boards. These different series of amplifiers utilize different technologies to achieve DSP, where the KABD series has a dedicated Analog Devices ADAU1701 DSP chip programmable with SigmaStudio, and 4th generation KAB Bluetooth 5.0 w/aptX HD. KAB amplifiers use an ARM based implementation of DSP that is programmable through the Dayton Audio KABX Windows software. Because of these different technologies, they require different interfaces to achieve programming. Rather than having multiple programmers for different purposes, Dayton Audio has integrated both technologies onto a single board that can be quickly switched back and forth into different programming modes and be used for programming as many amplifiers as desired. The KPX programmer can be thought of as the bridge between your KAB or KABD amplifier and your PC. It essentially will translate instructions from your computer in a way that the amplifiers DSP capabilities can understand. While it would be possible to integrate the DSP programming technology onto the KAB or KABD amplifier itself, this would add significant cost to each amplifier, and not only that, would increase the physical footprint of each amplifier. The KPX programmer can instead be used to program as many KABD or KAB amplifiers as desired, and removed once finished.

What Products are Compatible with the KPX Programmer?

USBi Mode (ADAU1701 DSP Chip / SigmaStudio)

KABD Series – This series of amplifiers, launching at the same time as the KPX Programmer, all house a Bluetooth 5.0 Module, a ADAU1701 DSP module and efficient class D amplification.

KABD-230 – 2 x 30 W

KABD-250 – 2x 50W

KABD-430 – 4 x 30W

KABD-4100 – 4 x 100W

DSPB Series – The DSPB series was the original line of amplifiers and DSP modules from Dayton Audio with class D amplification and integrated ADAU1701 DSP.

DSPB-K – Line Level DSP Board

DSPB-100 – 100W Mono Amp Board

DSPB-250 – 2 x 50W Stereo Amp Board

KABX Mode (ARM Based DSP)

Generation 4 KAB Series – At the time of writing, this newest generation of KAB amplifiers supporting Bluetooth 5.0 w/ aptX HD and can connect to the KABX DSP software.

KAB-250v4 - 2 x 50 W

KAB-230v4 – 2 x 30 W

KAB-100Mv2 – 1 x 100 W

Programming Dayton Audio Amplifier Boards with the KPX Programmer

The KPX Programmer is simple to use, however, usage will depend on the amplifier board you are connecting to the KPX programmer. If you are unsure if your amplifier is KABX software compatible or SigmaStudio software compatible, see the chart directly above and find the model of your amplifier. KABX compatible amplifier boards will have a 4-pin programming connector, whereas SigmaStudio compatible boards will have a 6-pin programming connector. The 4-pin connector uses UART to program the ARM based DSP in compatible KAB amplifiers, whereas the 6-pin connector uses IIC or SPI to program the dedicated SigmaDSP processor found in the KABD or DSPB series of amplifiers.

Required Items for Programming

- 1) KPX Programmer with included 4-pin and / or 6-pin cable
- 2) A KABX or SigmaStudio compatible Dayton Audio Amplifier Board
- 3) A USB Type C cable (Not included)
 - a. USB Type C is required for the end that connects to the KPX Programmer, but the other end can be either USB A or USB C depending on your Windows computer.
- 4) A Windows desktop or laptop running either SigmaStudio or the Dayton Audio KABX Software.



KPX Connection for KABX Programming (KABX Mode)

The KPX Programmer can be set to “KABX” mode to connect a compatible KAB amplifier board to the KABX Windows software. Make sure you set the switch on your programmer to “KABX” mode for this function. See the compatibility chart above for compatible amplifiers.

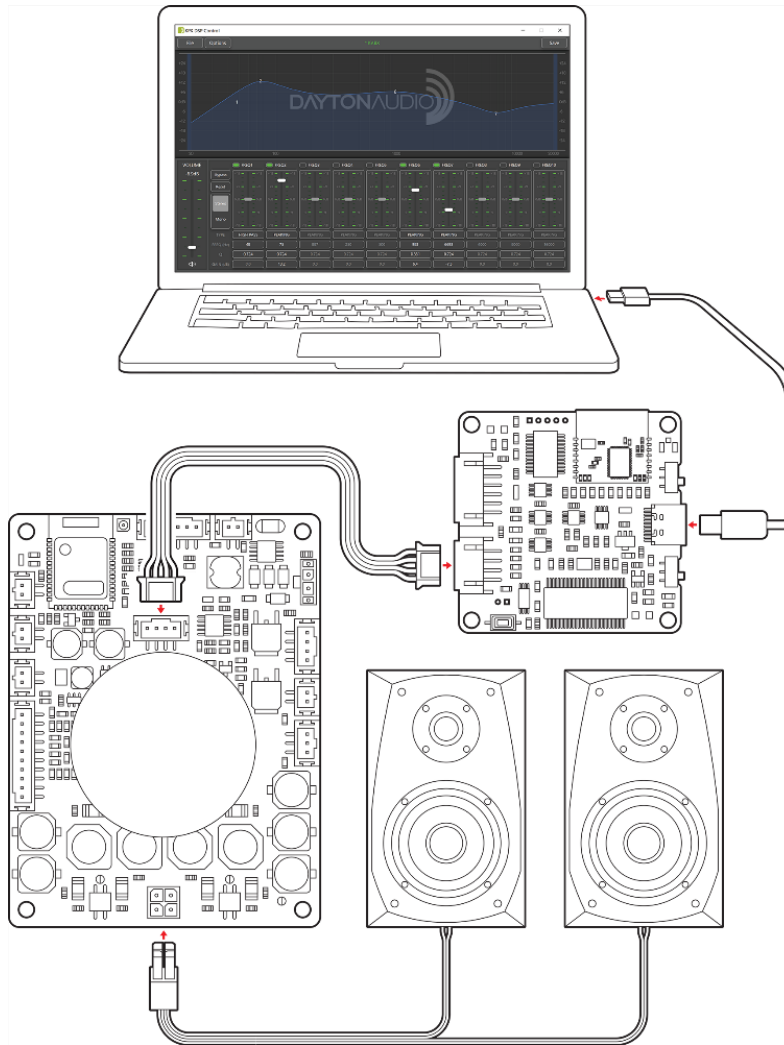

Pictured is a KAB-250v4 amplifier connected to the KPX programmer, which is connected to a Windows laptop running the KABX software.

- 1) Download and install the latest version of the KABX software from the KPX programmer product page or your amplifier board’s product page. The link to the software should be found in the exact same spot as this guide was found. Follow the instructions in the installer.
- 2) Before connecting to the DSP software, it is recommended to connect power, speakers and a Bluetooth source to your KAB amplifier and play some music to ensure all connections are correct and the amplifier is working properly before modifying DSP parameters.
- 3) Once all of the amplifier connections are made (speakers, power, audio source), you must **set the “USB Mode” switch on your KPX Programmer to “KABX” mode** (see back of board).

- 4) Connect your KPX programmer to your PC using your USB type C cable (not included, however if you have an Android phone, you should be able to use your charging cable). You will see the “RUN” led on your programmer light up.
- 5) Connect your KPX programmer to your KABX compatible amplifier board using the 4-pin cable included with the KPX programmer. The connection location will vary depending on the exact amplifier you are using, so refer to your amplifier’s specific documentation. For example, on the KABD-250v4, there is a 4-pin connector right under the heatsink (J12).
 - a. Make sure that your amplifier is powered for this step.
- 6) If not already open, open the KABX DSP software on your PC. If everything is completed correctly, you should find that you are connected immediately and can start making real time DSP changes.
 - a. If connected, the “KABX” label at the top of your screen will display green. If there is an asterisk * in front of the KABX logo, that means your changes have not been saved to non-volatile memory, which means your changes will be lost when your KAB loses power. To resolve this, simply hit the save button.

Notes: The KABX software is simple to use once connected, however if you are new to DSP or want additional information about the software, there is a separate KABX Software document that goes over the software’s capabilities, DSP techniques, etc. This document is highly recommended especially for new DSP users, or even experienced users, and can be found in the same location as this manual.

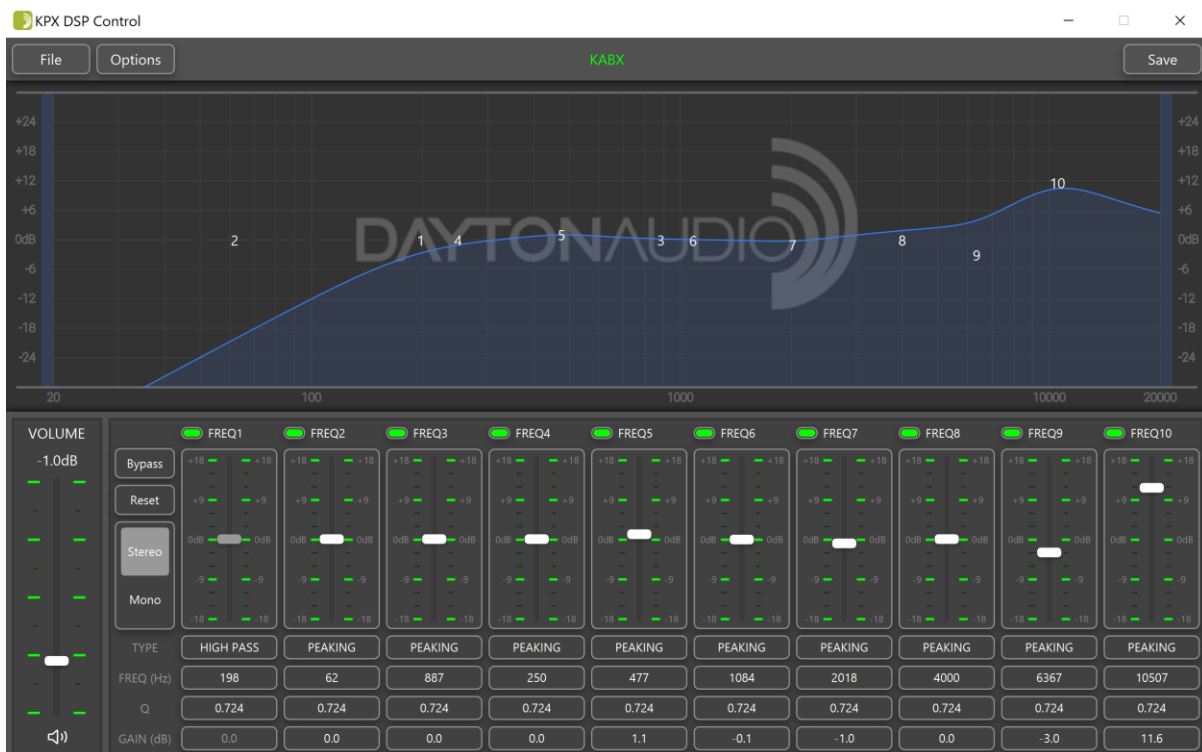

SigmaStudio Programming using the KPX Programmer (USBi Mode)

Below are general instructions for connecting a KPX programmer to a SigmaStudio compatible amplifier via USBi mode. For more specific instructions, see the manual for your specific KABD amplifier. Your KABD amplifier's manual will contain more information such as project examples, detailed images, and advanced usage in SigmaStudio. Additionally, there is a specific SigmaStudio programming guide for the KABD series of amplifiers, that goes over DSP techniques, DSP blocks of interest, programming instructions and so much more. This guide can be found on any KABD product page or wherever this manual was found.

It is important to follow the instructions below in the order they are written. Specifically, the KPX programmer must be connected to the PC before it is connected to your KABD amplifier.

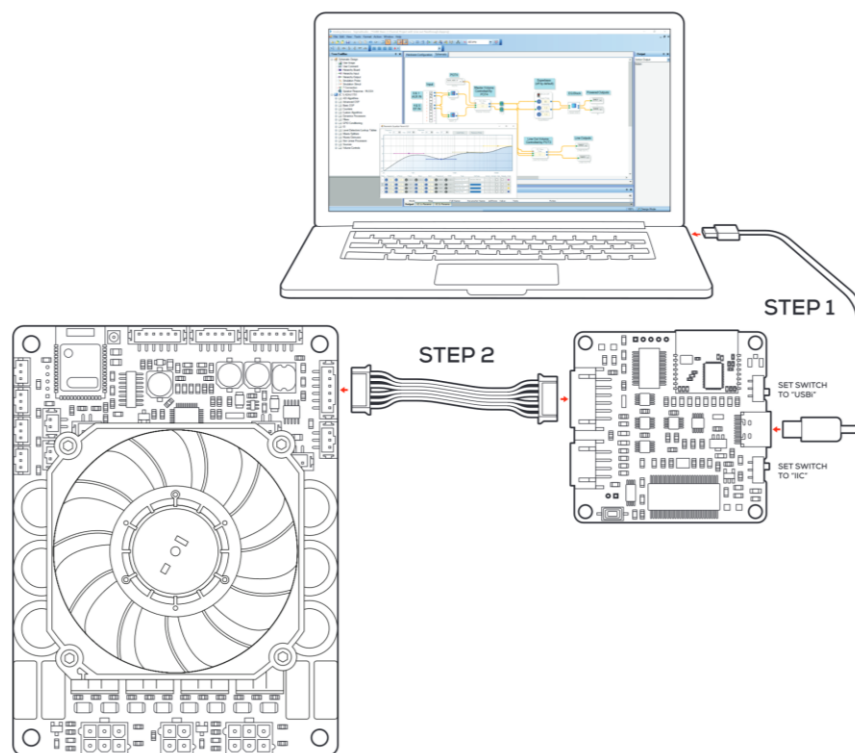

Pictured is a KABD-4100 amplifier connected to the KPX, which is connected to a Windows Laptop running the SigmaStudio software.

1. [Download and install the most recent version of SigmaStudio to your system for free from Analog Devices, the maker of the DSP chip and the software.](#)
2. Make sure your KPX programmer is disconnected from USB and from your KABD amplifier before starting, to ensure the proper steps are taken. Do not connect the 6-pin cable yet.
3. Ensure that your KPX is **not** yet connected to the KABD. **Set the switches on your KPX to “USBi” and “IIC”** for proper programming with the KABD or DSPB amplifier (IIC Mode is used for ADAU1701 DSP Chips).
4. Plug a USB C cable into the PC running SigmaStudio, and then connect that USB cable to your KPX programmer.

5. If all is correct, you will see the USB block turn green, like below.

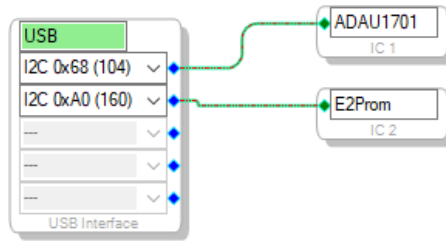

- a. Note that this block turning green means that SigmaStudio recognizes your programmer, **it does not indicate that SigmaStudio can communicate with your KABD amplifier yet.**
 - b. If the connection is not successful (the block stays orange),
 - i. Disconnect all cables from the KPX (6-pin cable, 4-pin cable), and then plug in the USB cable to the KPX.
 - ii. it is important to try a different USB cable, even if it is a 'good cable'. Many USB cables endure a lot of abuse from charging devices, and although they might still provide power, they might have issues transferring data.
 - iii. It could be a driver problem that can be resolved by reinstalling SigmaStudio, using a different USB port, manually uninstalling the driver from Device Manager and then reconnecting the KPX.
 - c. using a different USB port, manually uninstalling the driver from Device Manager and then reconnecting the KPX.
6. If not already, make sure your KABD is now connected to its own power source.
 - a. If the PC connected programmer is plugged into the KABD, but your KABD does not have its own power, it will light up LEDs on the KABD (making the amplifier look like it is powered), but it will fail to program and function. **The KABD needs to be connected to its own power source for proper programming.**
 7. Plug the 6-pin connector on the KPX programmer to the 6-pin programming port on the KABD amplifier. Your programmer comes with this 6-pin cable. **Make sure that you connected your programmer via USB to your PC BEFORE completing this step.**
 - a. Note: The KPX has two ports, but you will use the 6-pin port for programming the KABD series of amps (USBi Mode).
 8. You are now ready to make your own projects in SigmaStudio like the image below, or to use example projects and modify parameters for your project.

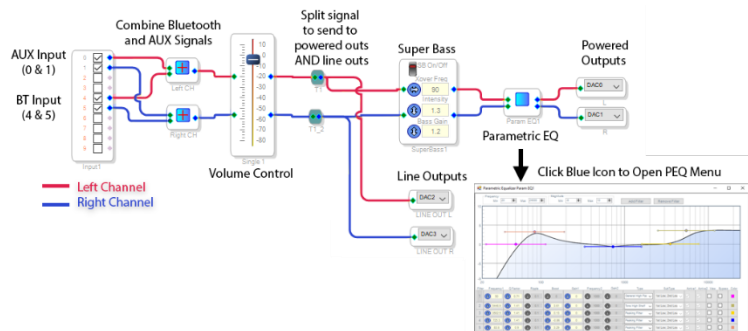

Example SigmaStudio Project

Upgrading your KPX Programmer

Although not usually required, in the future there might be an update for the firmware of your KPX programmer. To check for updates, or to update your KPX if you know there is an update available, follow the steps below. If you are having issues with your KPX programmer, you can try this upgrade to restore factory settings even if there is not a new upgrade available.

- 1) Unplug everything from your KPX programmer.
- 2) Hold the upgrade button (shown below) and plug in your KPX programmer to your Windows PC while continuing to hold down this button.

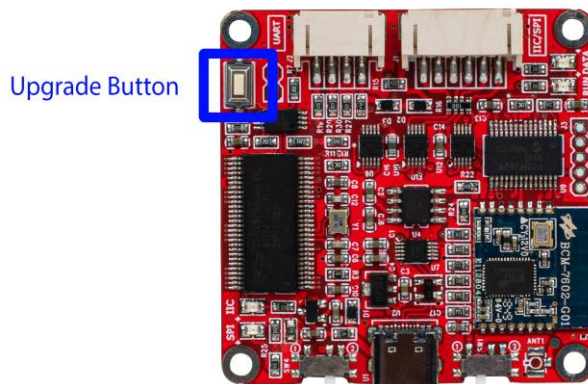

- 3) Once connected, you will see the “run” LED blinking. If it is solid, try the previous steps again.
- 4) Open the KPX software (downloadable from the product page)
- 5) Open the ‘options’ menu, and press ‘upgrade’.

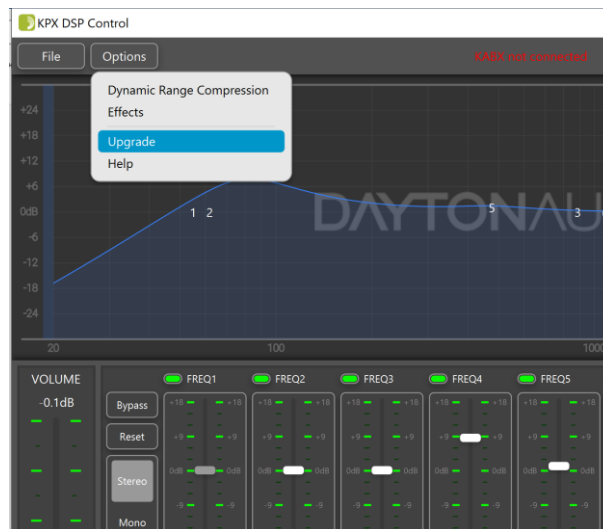

- 6) The steps will complete automatically. You can then disconnect your USB cable, reconnect it and use your KPX normally.

Additional Documents

There are numerous other documents available to assist you with your projects once you have made your desired connections with the KPX programmer. These documents can be found either on the product page for the KPX programmer, or the product page for your specific KAB / KABD amplifier.

- **KABD Amplifier Series User Manuals** – Each KABD series amplifier has a dedicated manual with extensive information, projects examples, advanced usage information, etc.
 - KABD – 230 / 250 Manual
 - KABD – 430 Manual
 - KABD-4100 Manual
- **SigmaStudio Programming Guide for the KABD Series** – This document has extensive SigmaStudio programming information, and will be useful for beginners and experienced users alike. It goes over DSP concepts and how to use them within SigmaStudio and also how they directly apply to the KABD amplifiers.
- **KABD Series SigmaStudio Example Projects** – This ZIP file contains numerous SigmaStudio project examples for each the KABD-250/230, KABD-4100 and KABD-430.
- **KABX Software Guide** – This document goes over all of the capabilities and usage information for the KABX software.