



CLASS-D SUBWOOFER AMPLIFIER with DSP

Model: SPA1200DSP /
SPA2400DSP
User Manual

Safety

1. Read these instructions.
2. Keep these instructions.
3. Heed all warnings.
4. Follow all instructions.
5. Do not use this apparatus near water.
6. Clean only with dry cloth.
7. Do not block any ventilation openings. Install in accordance with the manufacturer's instructions.
8. Do not install near any heat sources such as radiators, heat registers, stoves, or other apparatus (including amplifiers) that produce heat.
9. Do not defeat the safety purpose of any polarized or grounding-type plug. A polarized plug has two blades with one wider than the other. A grounding type plug has two prongs and a third grounding point. The wide blade or the third prong are provided for your safety. If the provided plug does not fit into your outlet, consult an electrician for replacement of the obsolete outlet.
10. Protect the power cord from being walked on or pinched particularly at plugs, convenience receptacles, and the point where they exit from the apparatus.
11. Only use attachments/accessories specified by the manufacturer.
12. Use only with the cart, stand, tripod, bracket, or table specified by the manufacturer, or sold with the apparatus. When a cart is used, use caution when moving the cart/apparatus combination to avoid injury from tip-over.
13. Unplug this apparatus during lightning storms or when unused for long periods of time.
14. Refer all servicing to qualified service personnel. Servicing is required when the apparatus has been damaged in any way, such as power-supply cord or plug is damaged, liquid has been spilled or objects have fallen into the apparatus, the apparatus has been exposed to rain or moisture, does not operate normally, or has been dropped.
15. **WARNING:** To reduce the risk of fire or electric shock, this apparatus should not be exposed to rain or moisture and objects filled with liquids, such as vases, should not be placed on this apparatus.
16. To completely disconnect this equipment from the mains, disconnect the power supply cord plug from the receptacle.
17. The mains plug of the power supply cord shall remain readily operable.

IMPORTANT SAFETY INSTRUCTIONS

To reduce the risk of electric shock, do not remove cover. No user serviceable parts inside. Refer servicing to qualified personnel. To reduce the risk of fire and shock do not expose unit to rain or moisture. The unit should be connected to an earth grounded AC electrical socket. The unit should be operated in a well ventilated area. Minimum clearance is 2 inches from the ventilation openings.



FCC Statement

1. This device complies with Part 15 of the FCC Rules. Operation is subject to the following two conditions:

(1) This device may not cause harmful interference.

(2) This device must accept any interference received, including interference that may cause undesired operation.

2. FCC Radiation Exposure Statement: Mobile device.

This equipment complies with FCC radiation exposure limits set forth for an uncontrolled environment. In order to avoid the possibility of exceeding the FCC radio frequency exposure limits, Human proximity to the antenna shall not be less than 20cm (8 inches) during normal operation.

Operating Guide: Dayton Audio SPA1200/2400DSP

Subwoofer Power Amplifiers

Table of Contents

Back panel and input/output (I/O) definition	5
SPA1200DSP and SPA2400DSP wiring	6
Feature control-panel key	7
Amp system block diagram	8
Controlling your subwoofer via PC GUI	9
Feature menu display	12
iOS remote control “app” guide	14
Firmware update guide	16
DSP and Performance Specification	20-21

Back panel and input/output (I/O) definition

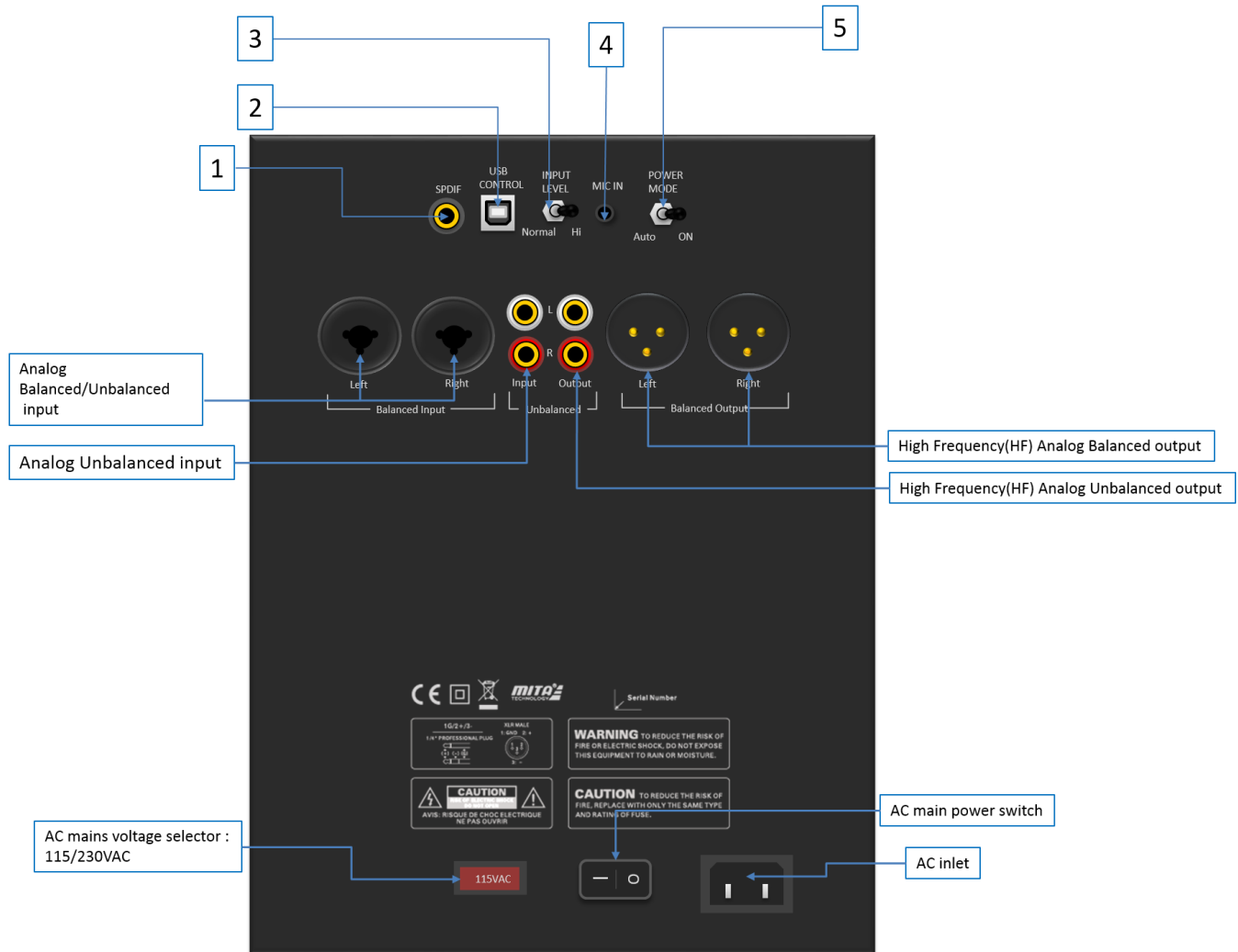

1. SPDIF coaxial input: Select between digital SPDIF and analog (XLR or RCA) audio inputs by navigating to and electing desired “Input Source”, via the amp’s dedicated feature control menu knob or software GUIs.

2. USB Control: Use for PC-GUI communication with custom PC software included with your amp. Please refer to **PC-GUI user guide** on page 5. USB also allows for **firmware update** by Dayton Audio release. See Page 10 for more on the system “flash” update process.

3. Analog input attenuation: Affects analog balanced and unbalanced inputs only.

- **Normal:** No attenuation.
- **Hi:** Attenuates input signal -6dB.

4. MIC IN: Services amp’s *Intelligent Room-EQ (iEQ™)* microphone connection

5. Power Mode: Select the either energy-saving or “always-on” power mode

- **Auto:** Amp goes into standby after no detected signal input for 15 minutes*
- **On:** Amp is always on, regardless of input signal status.

* Amp will automatically turn on typically in one second or less once audio signals are resumed.

SPA1200DSP and SPA2400DSP wiring

■ SPA1200DSP

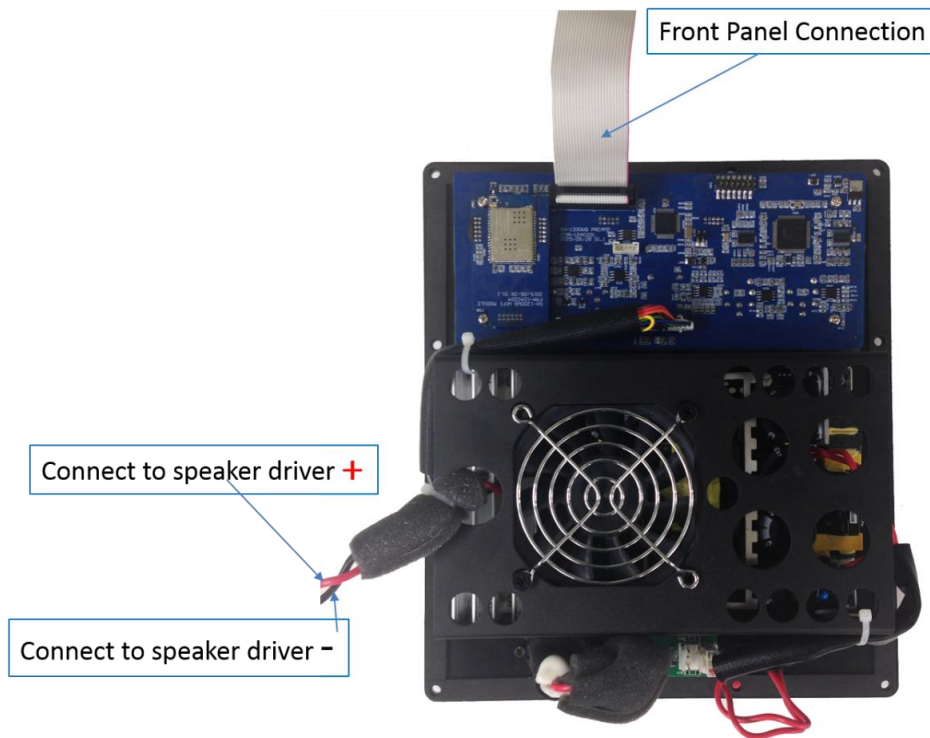

■ SPA2400DSP - **NOTE:** Do NOT bridge outputs. Dual voice coil and dual driver loads only!

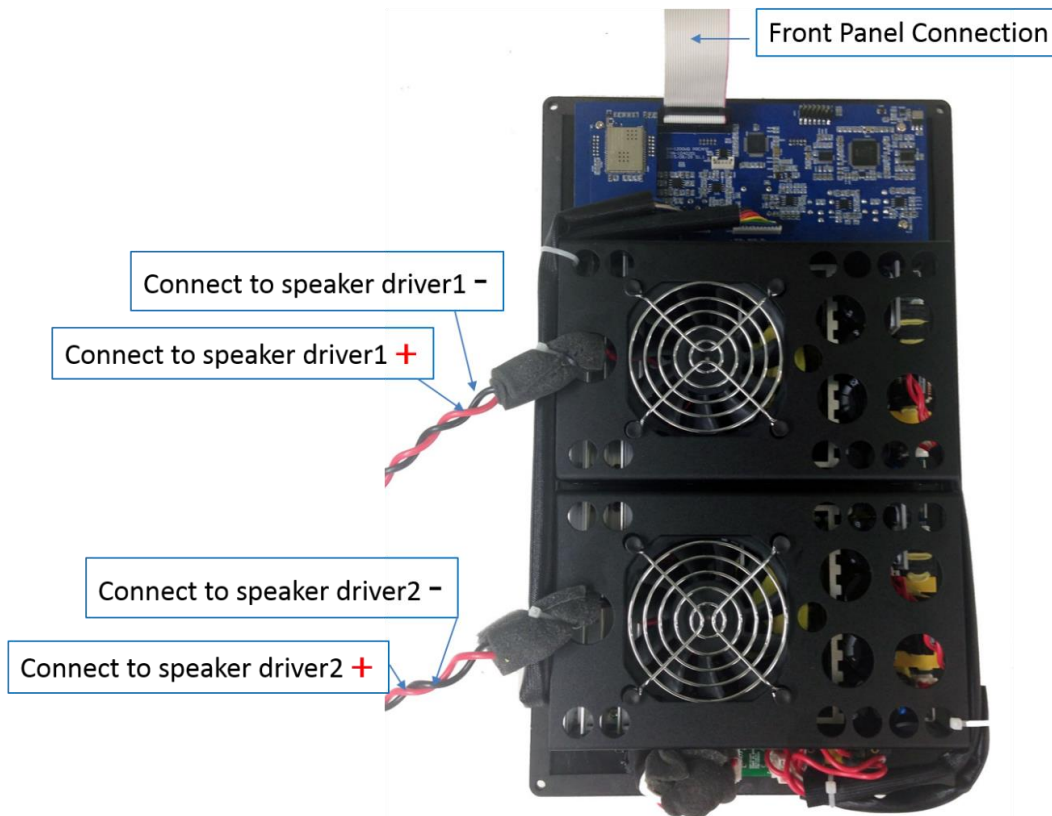

Feature control-panel key

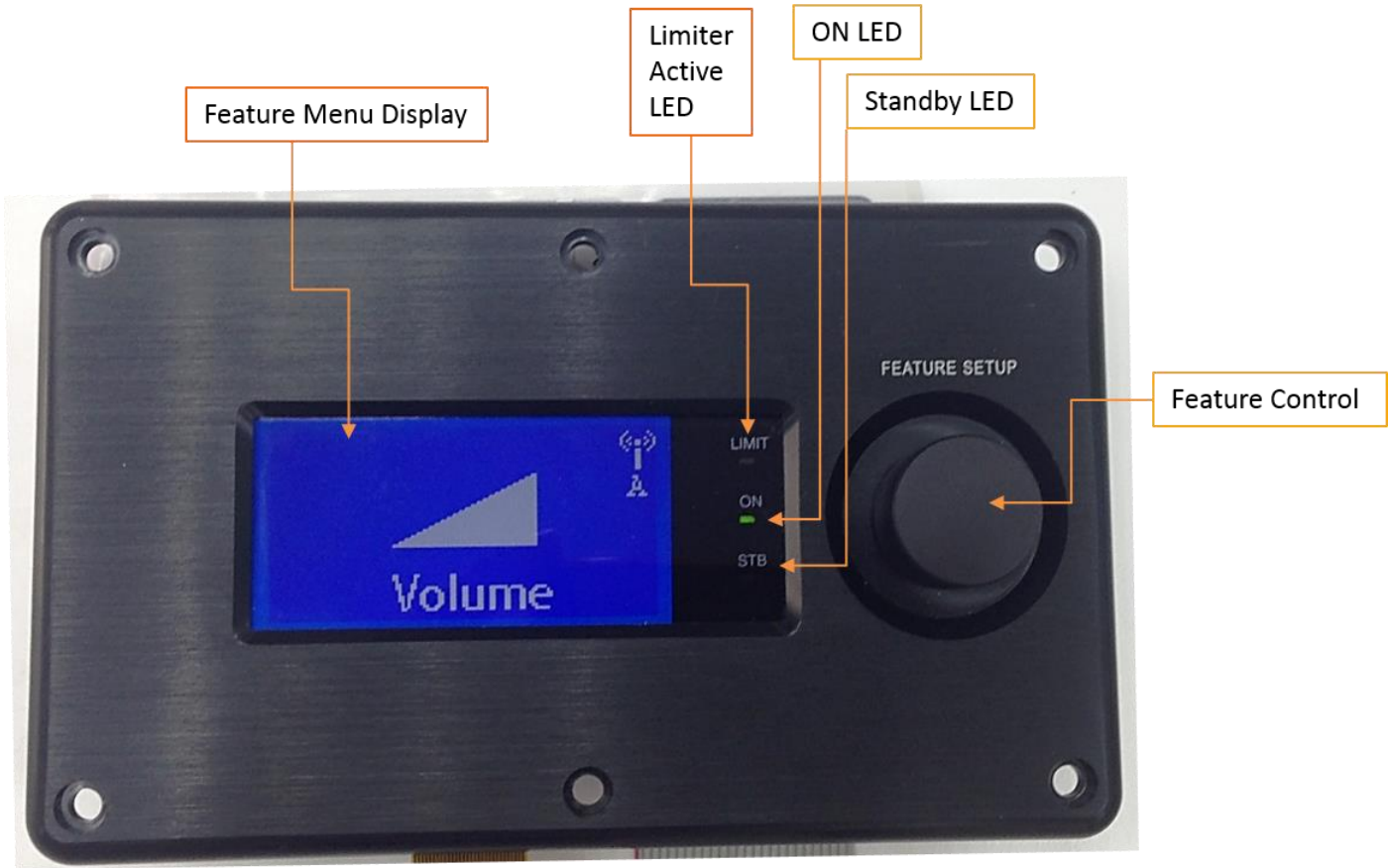

- **Power ON LED:** Green LED when amp is operating normally
- **Standby (STB) LED:** Red when amp is in energy saving “stand by” state
- **LIMIT LED (Yellow):** Lit when Limiter is active
- **FEATURE SETUP:** Single knob digital actuator with single/double-click enabled with rotary scrolling to navigate the amp’s extensive feature menu.
- **Feature controller display (128 x 64 pixel):** Liquid Crystal Matrix (LCM) displays all of the feature menu and status.

Amp system block diagram

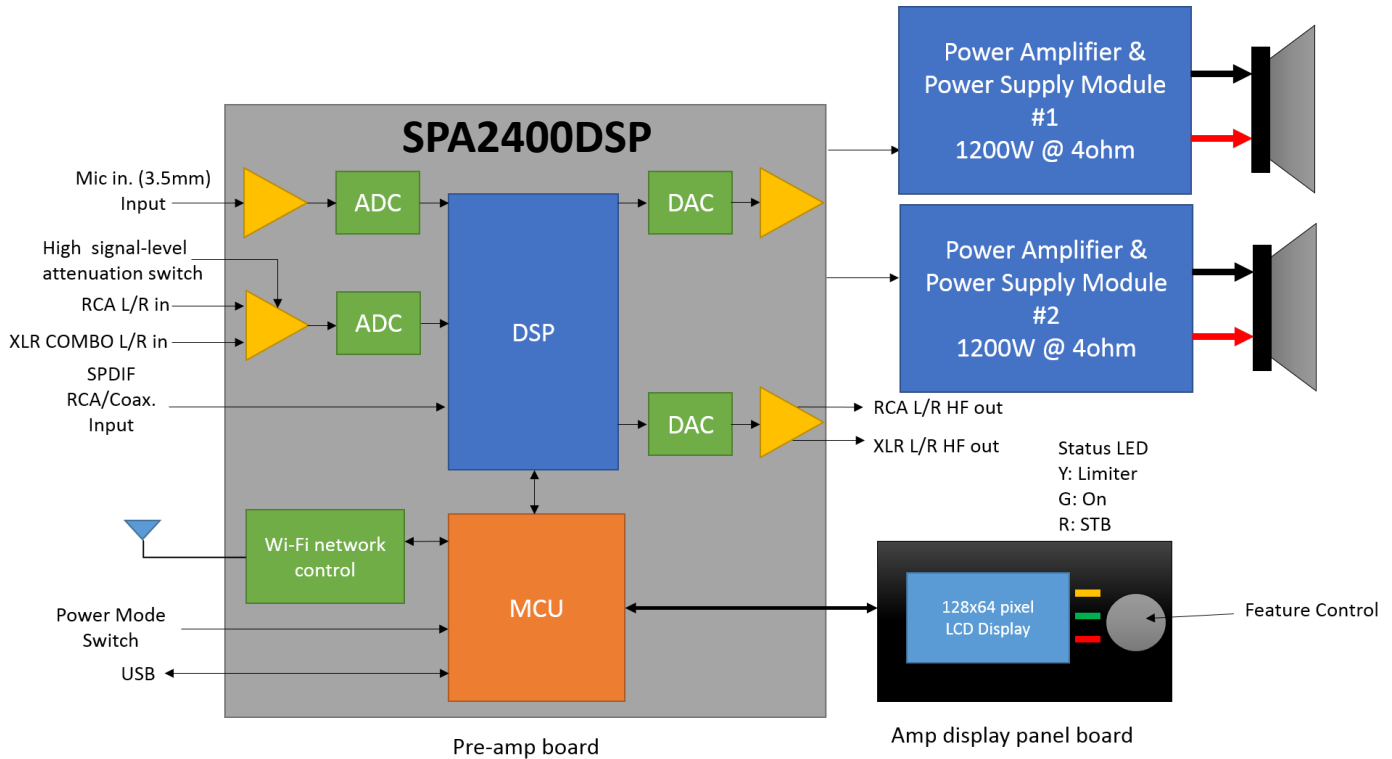
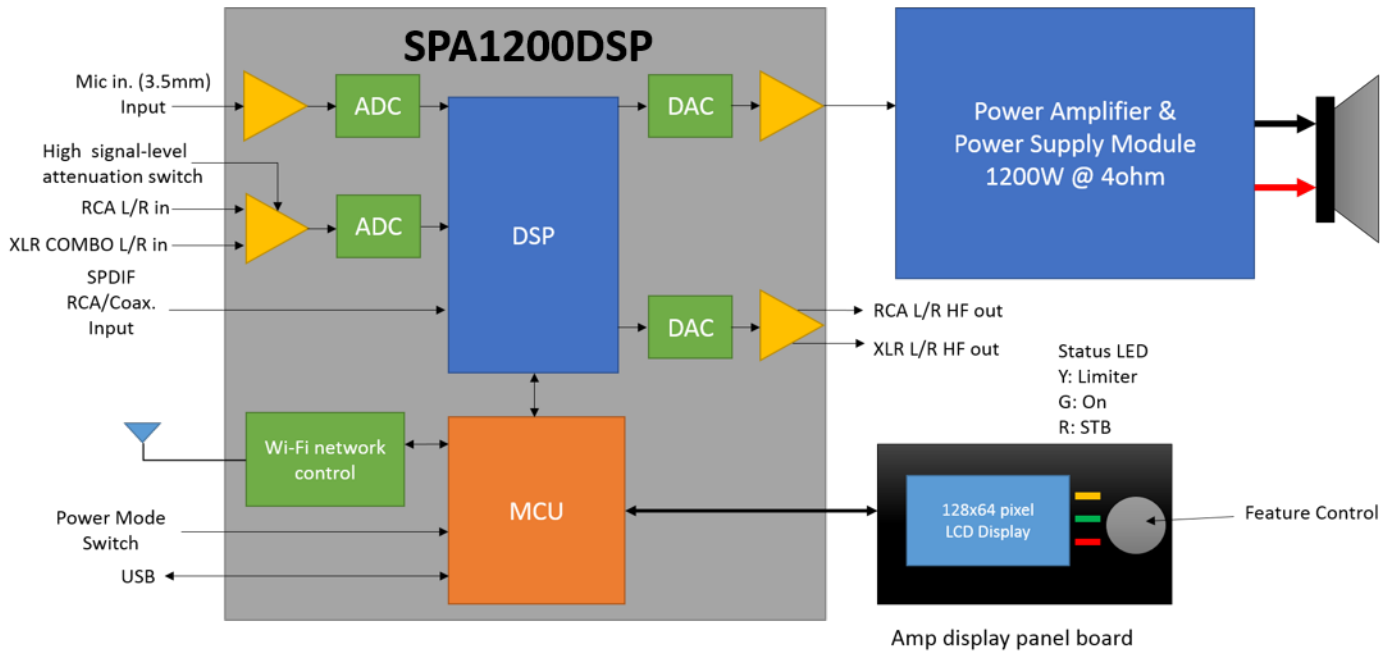

DSP processing block diagram

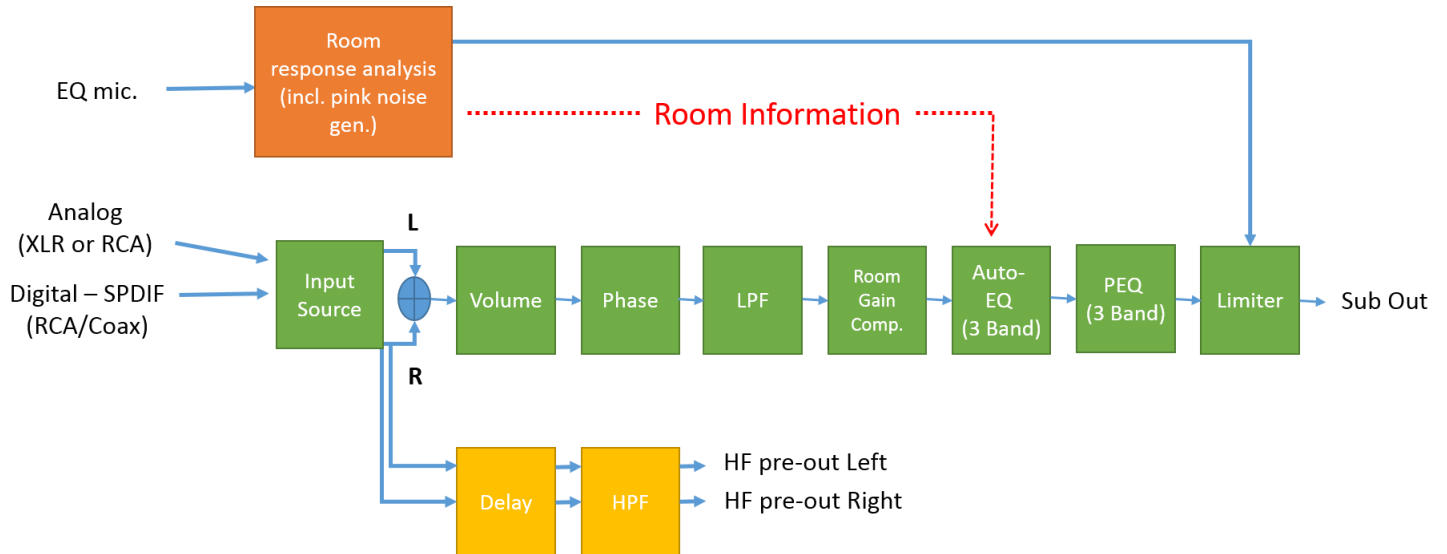

Controlling your subwoofer via PC GUI

The PC GUI (literally, “Personal Computer, Graphical User Interface”) is the primary mode to access and adjust the DSP for subwoofer optimization. Follow all safe practices and contact Dayton Audio if you require assistance.

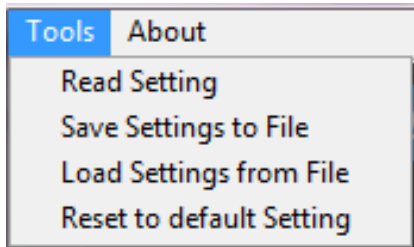

Read Setting: Read all the setting from amp

Save Settings to File: Save current settings to PC

Load Settings from File: Load previous saved setting to AMP

Reset to default setting: Reset the AMP to factory default

See next page: For a full depiction of the primary screens and detailed identification of each of your amp GUI’s controls.

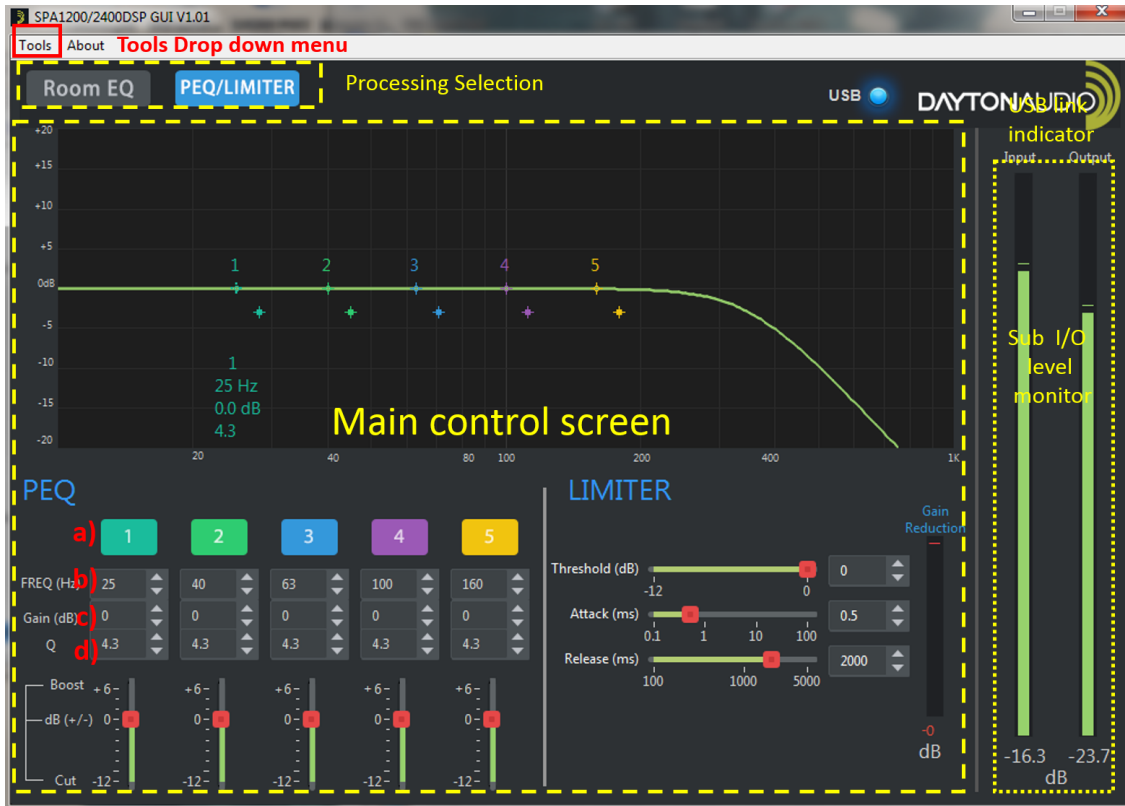

- **USB Link Indicator:**  When communication via USB with amp is successful, the GUI's "LED" indicator will light blue. Otherwise, the "LED" stays dark.
- **Processing Selection:** Selecting any icon can effect change in near-real time (NRT) to the amp's audio outputs.
- **Main Control Screen:** Control each DSP processing parameters: Threshold Power, Attack Time, Release, along with 5 digital PEQ bands
- **Sub In/Out monitor:** Monitor the input signal and sub output signal levels.
- **Tools Drop Down Menu:** Utilities for amp DSP management, plus Wi-Fi settings.
- **Note:** The GUI's graphical trace is NRT editable. Bands can be shaped by cursor or direct input and/or sliders.
- **Detailed tool tips (shown a-d above):**
 - **5 band-digital PEQ**
 - a) **Band On/Off:** Bypass or enable by clicking the colored 1 ~ 5 buttons.
 - b) **Center Frequency (CF):** Adjust Center Frequency of each EQ band, 20 ~ 200Hz. Steps: 1Hz.
 - c) **Gain:** Adjust the EQ gain (apparent volume), -12 ~ +6dB. Steps: 1dB.
 - d) **Q (EQ width):** Adjust the "Q" value, 0.4 ~ 11. Steps: 0.1Q.
 - **Limiters:** Adjust, optimize, save, recall.
 - a) **Threshold:** Adjust the limiter "threshold power", 0 ~ -12dB. Steps: 0.1dB
 - b) **Attack:** Adjust limiter "attack time". This controls the allowed of time signals may be over threshold power. Range of adjustment is 0.1 ~ 100ms (milliseconds). Steps: 0.1ms
 - c) **Release:** Adjust limiter's "release time". When limiter is triggered, this control adjusts the time allowed to restore full power. Adjustable range 100 ~ 5000ms. Steps: 0.1ms.

Custom algorithms apply intelligent multi-band room equalization (iEQ™)

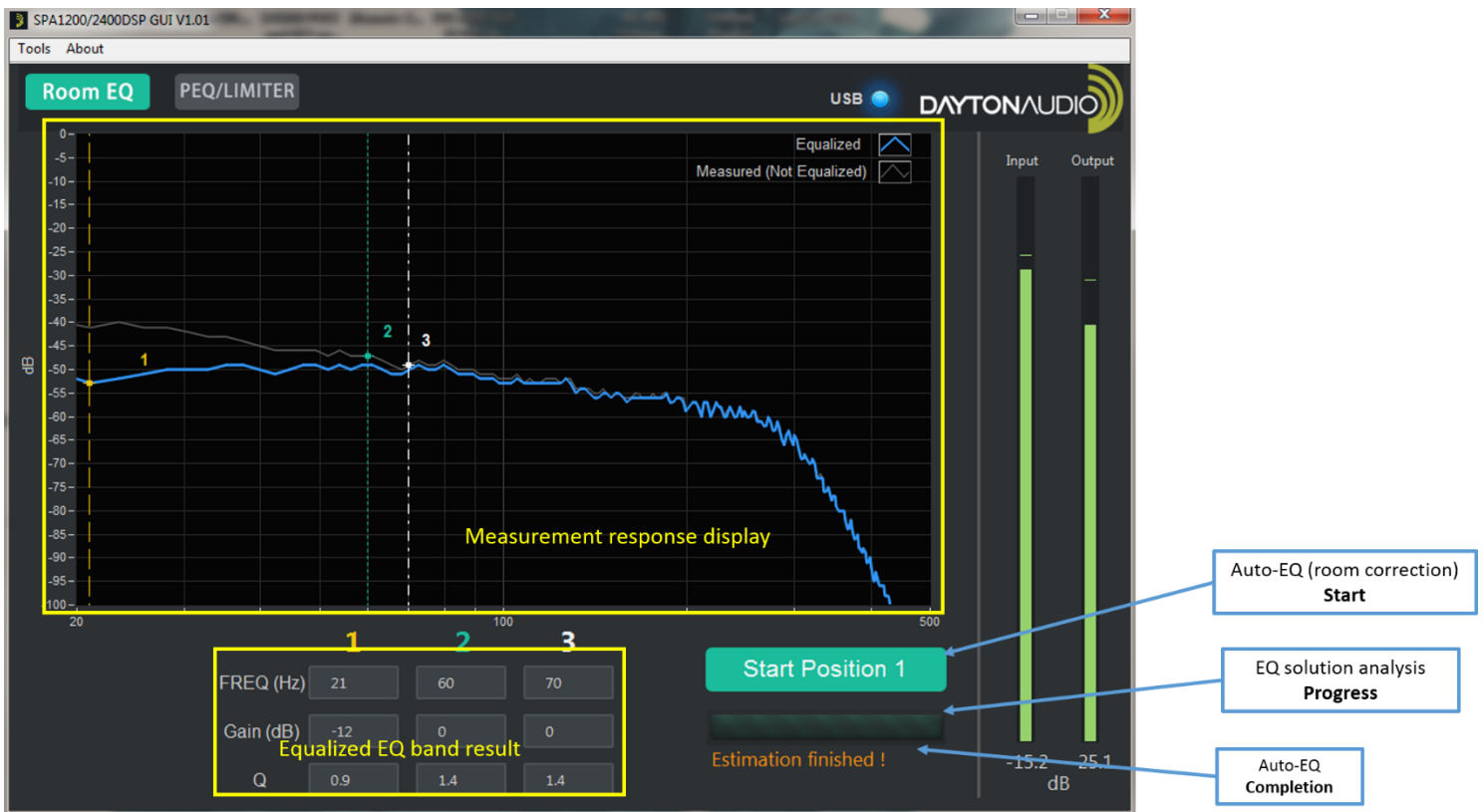

The included 20Hz-capable iEQ microphone allows estimation of your room’s natural frequency response characteristics and precisely applies PEQ filters to compensate for inevitable response anomalies. Plug the microphone’s 3.5mm “male” fitting into the amp panel’s “female” jack labeled “Mic In” for this procedure.

Measurement of room acoustics requires moving your EQ mic through the room’s listening and/or viewing “sweet spots”, typically affixed to a photo tri-pod for best acoustical results. Only three different positions are required, as testing actually captures 12 measurements *per location* (automatically averaging each result).

Starting iEQ: Selecting the GUI’s **Start Position 1** button starts custom calibration test tones. After moving your mic to three different listening locations and estimations are finished, the system screen will display the final measured GUI and calculated post-equalized frequency response results.

Control-Panel: Feature Menu Display

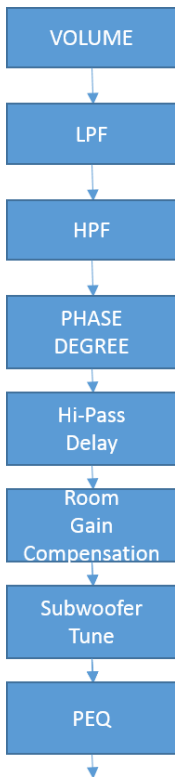
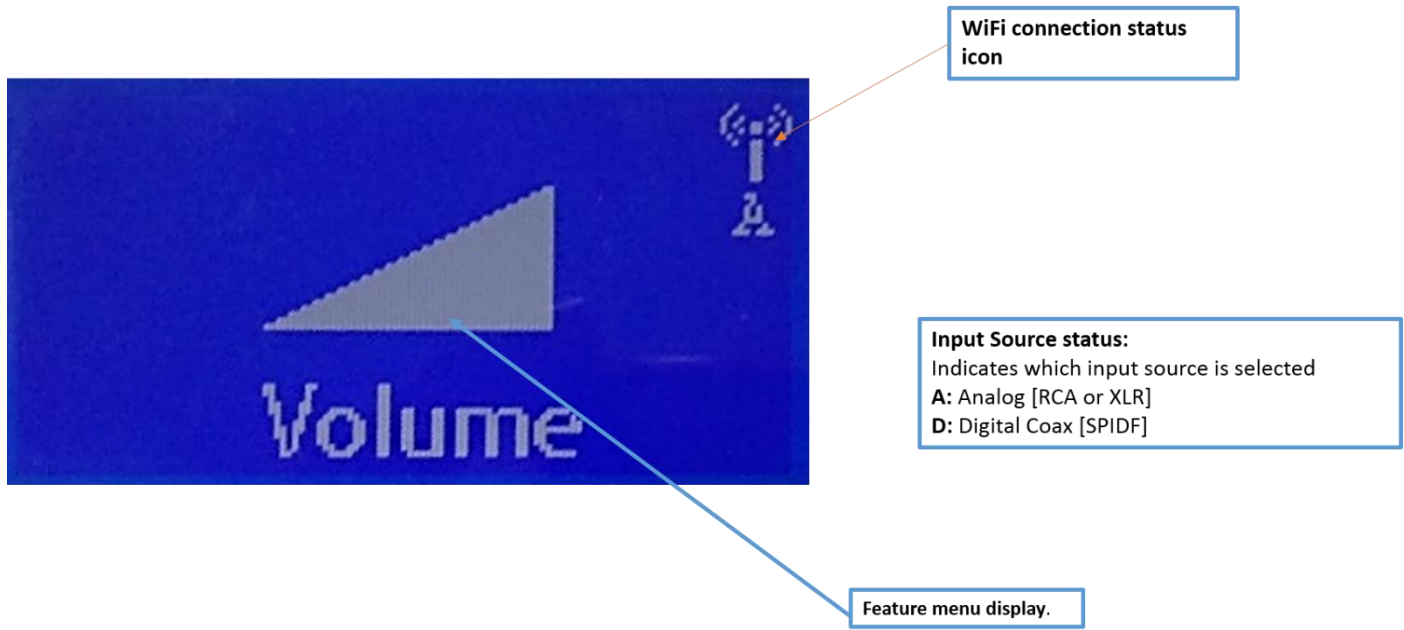

Volume, Phase, Low-Pass Filter and all other controls are also accessible via the included rotary control.

Volume (shown above) is selected by a single click, upon which simple rotation allows 1dB adjustment. A “double-click” brings you back to the main menu. Subsequent rotation of the controller from the main menu navigates you through a series of setup menus.

Each of the “Function frames” at left correspond to the major feature controls on the amp. Each feature control uses the same single/double-click navigation. Note all detailed sub-features on the next page. Scroll around your amp and get familiar with its simple click and double click feature rotation.

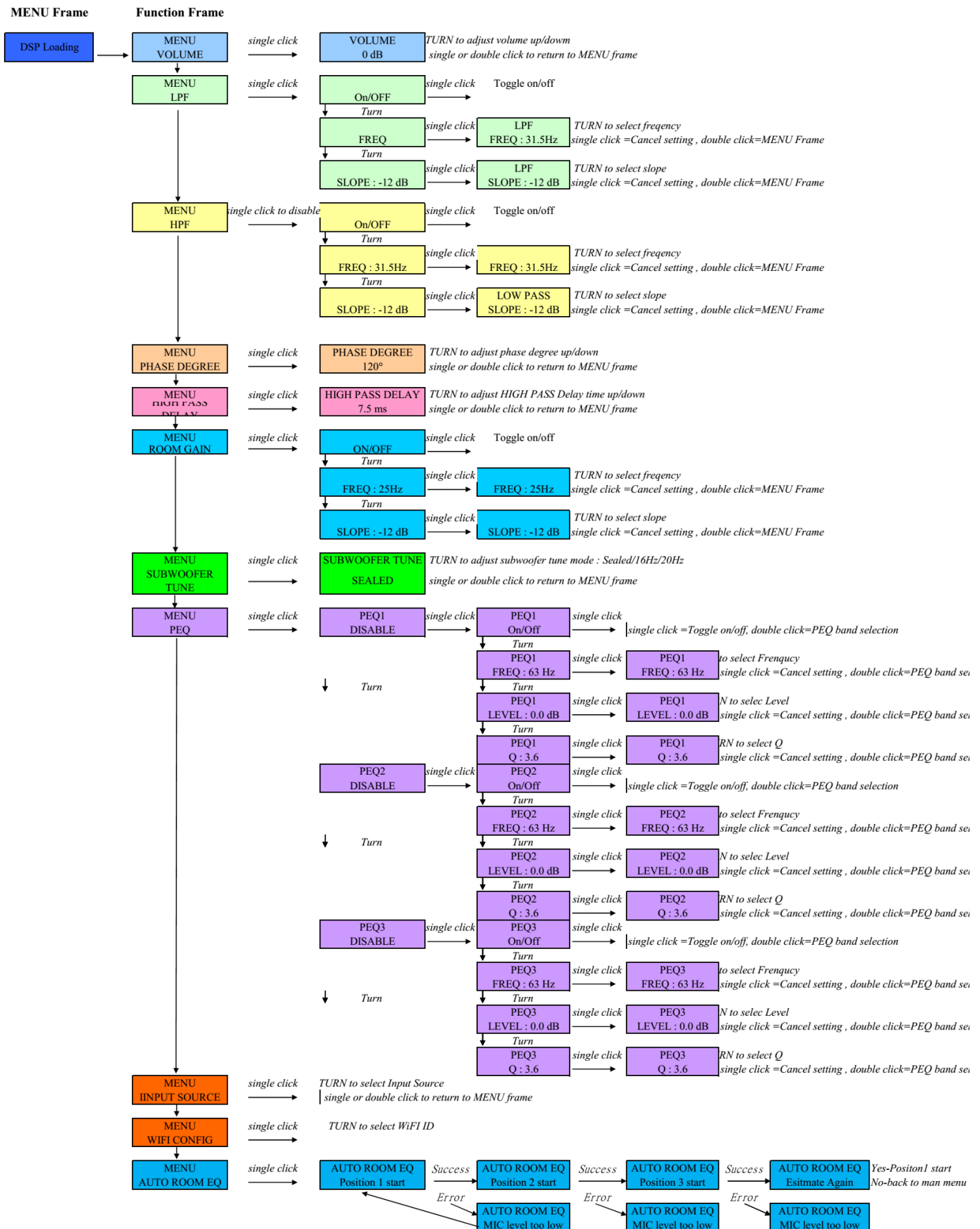

iOS Subwoofer Remote Control “App” Guide

Your SPA1200 or 2400DSP amp has its own internal Wi-Fi communication chip to allow for tuning and setup of your sub remotely via the dedicated Dayton Audio SubRemote iPhone Control “App”.

1. Download the App from this link: <https://itunes.apple.com/us/app/sub-remote-control/id1064820366?mt=8> or search for “SubRemote” from Apple® “App Store”. Alternatively, you may scan the QR code (left) for a direct link to the App Store download page:



Discover the app (click page for description) →

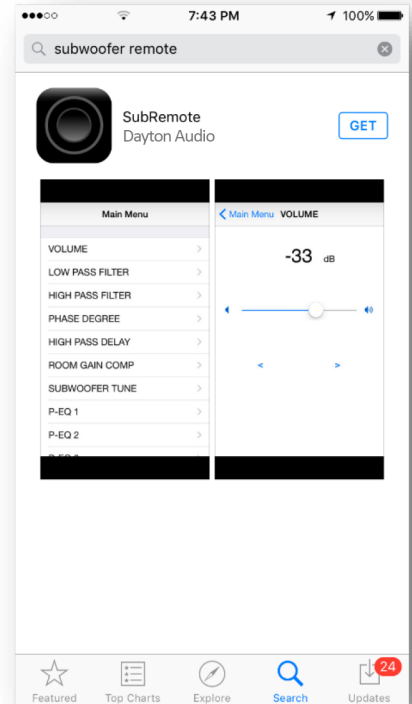

2. Connect your iPhone to SPA1200 or 2400DSP sub amp from your iPhone’s Wi-Fi setting panel:

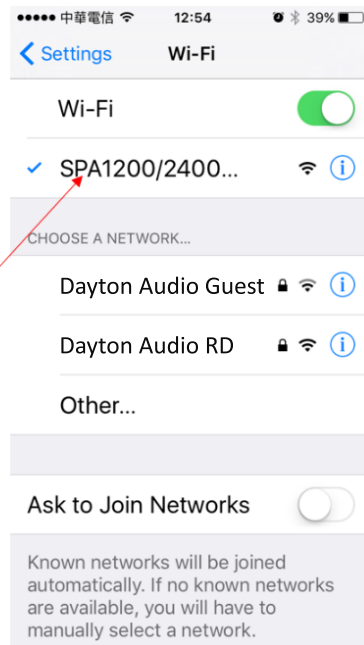
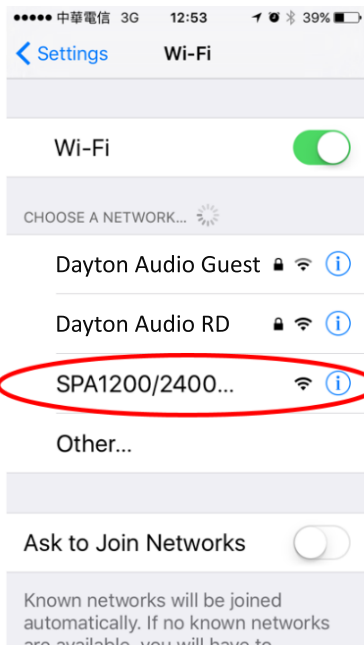

3. Once the Wi-Fi successfully links to the sub, open the app to remotely control your sub's amp.

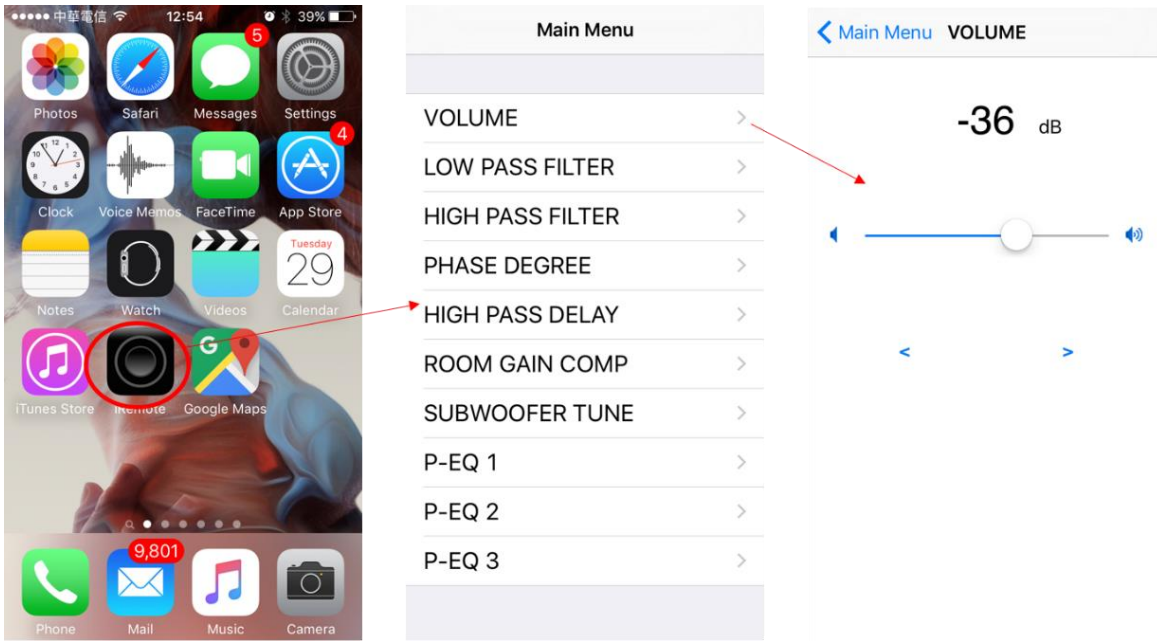

Note: If you have **not** connected your iPhone to the amp, the app will automatically enter “demo mode”. The demo mode is just a demonstration of each function. Optimally “smooth” operation is not functional in demo mode, but each screen can be navigated for familiarization. Only when connected to via Wi-Fi can your sub’s amp be manipulated however.

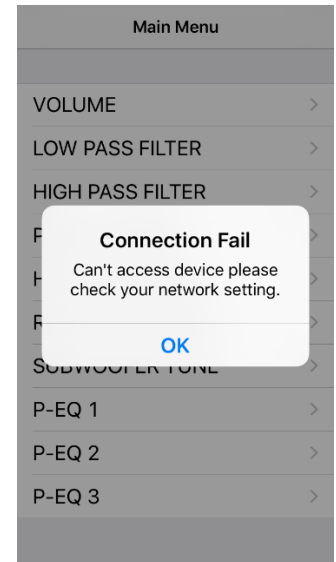

Firmware Update Guide:

Bug fixes or feature improvements may be introduced via Dayton Audio “firmware” updates. Use this procedure if such an update is provided to all amp owners:

1. Turn off the amp from the main power switch (next to power cord inlet).
2. Press and hold the control-panel’s feature rotary knob, and then turn on the amp. The device will immediately enter the firmware upgrade mode. When the device successfully enters this mode, the “Standby” (STB) LED will begin blinking.
3. Connect your PC’s USB cable to the USB jack on amp’s back panel. When the connection is successful, in Windows 7® or later “Device and Printers” will allow you see a new “USB HID Bootloader” device.

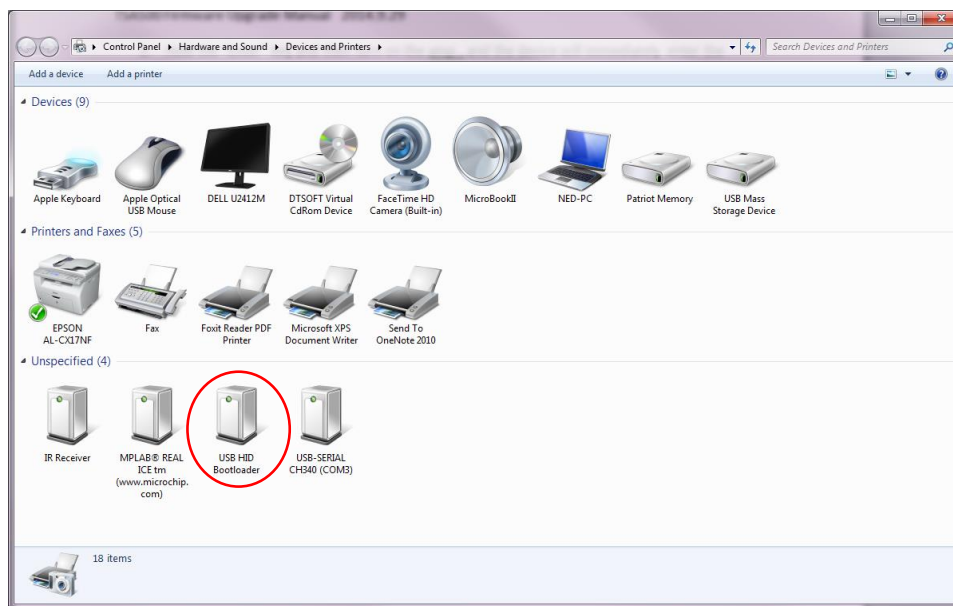

4. Open the “Firmware Updater” (application provided on your Dayton Audio amp software CD), and press “Connect”. When successfully connected, the below panel will appear:

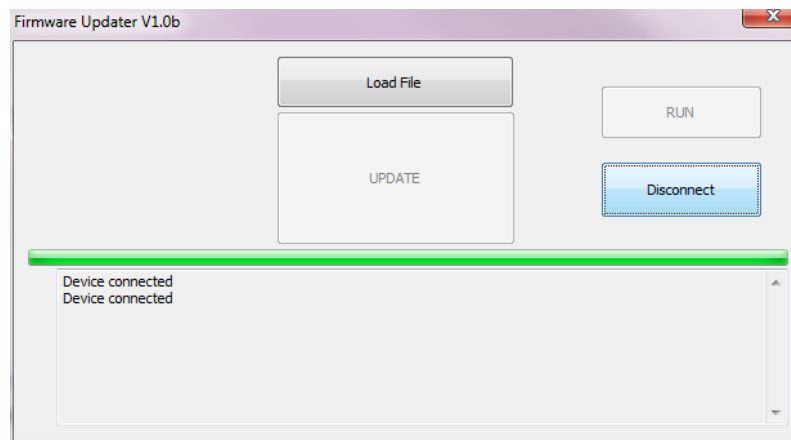

5. Load the updated firmware file from your saved location and select which new version by clicking the above “Load File” button:

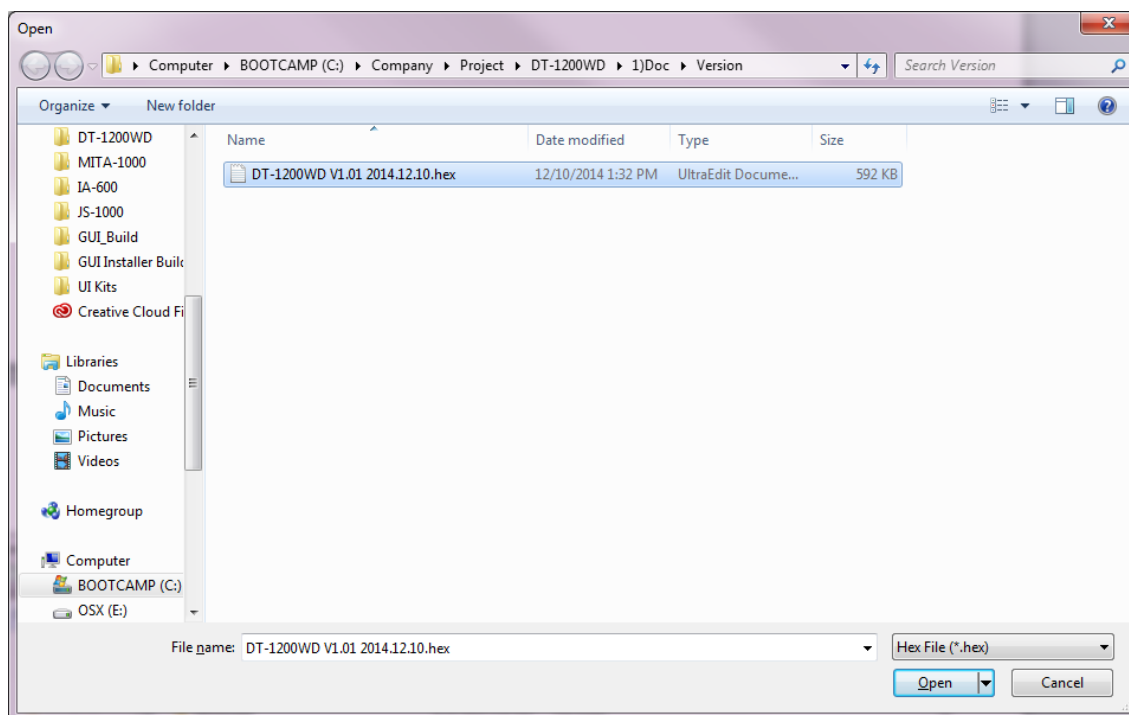

6. When the firmware update is loaded, the below panel and green “progress bar” will show:

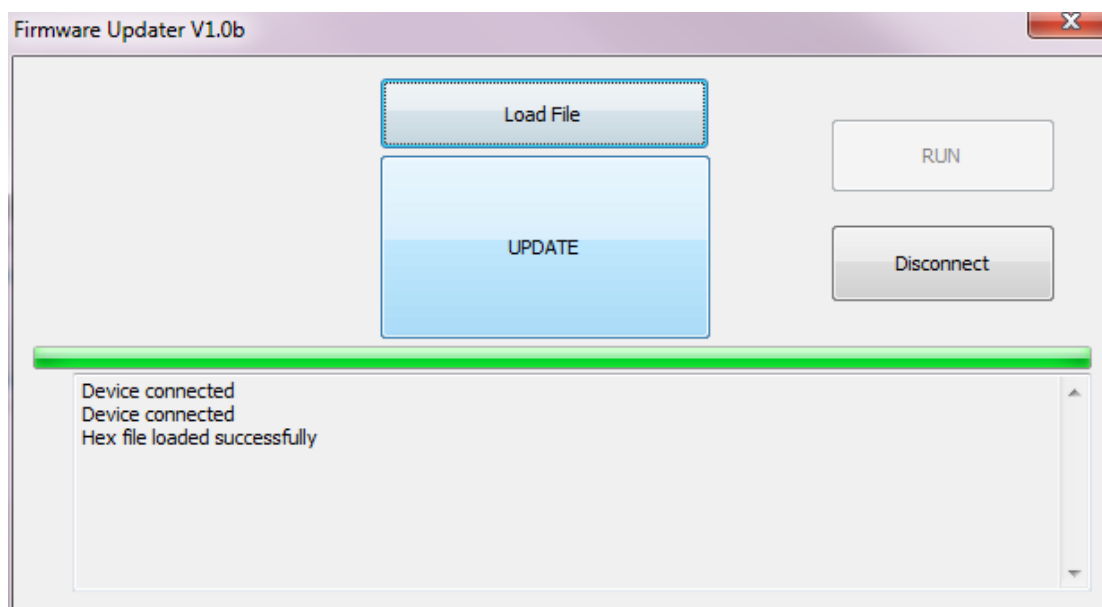

7. Press "UPDATE" and the firmware will begin installation:

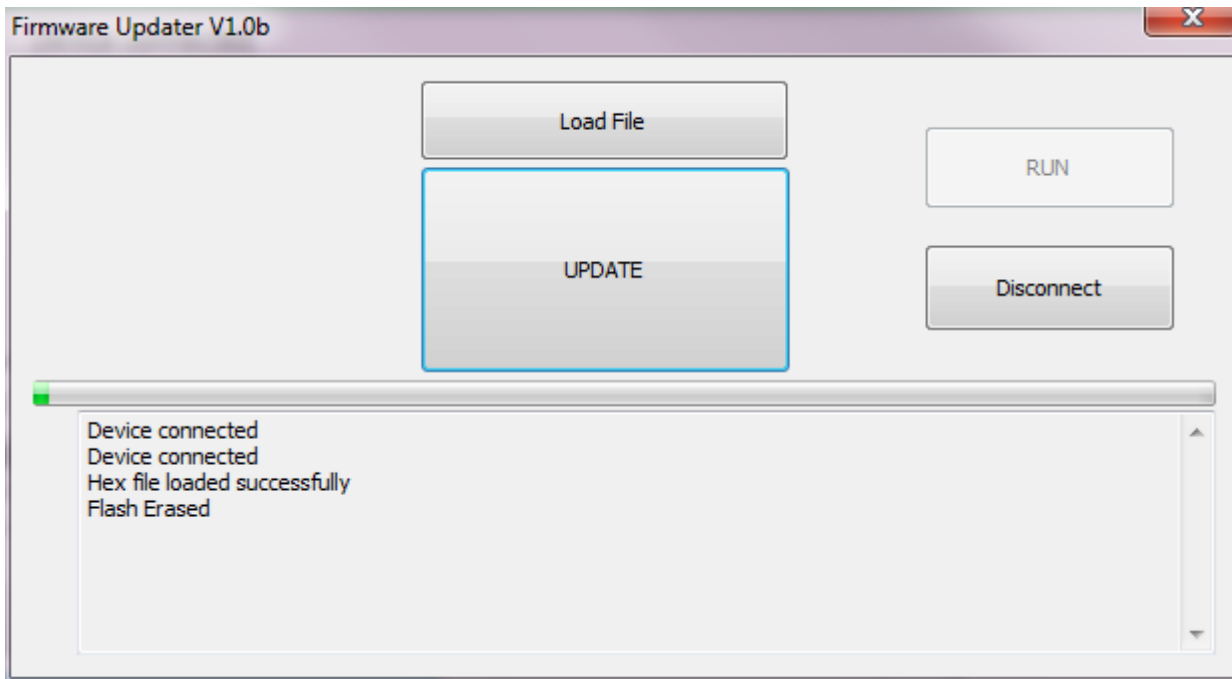

8. After installation is complete the panel shows:

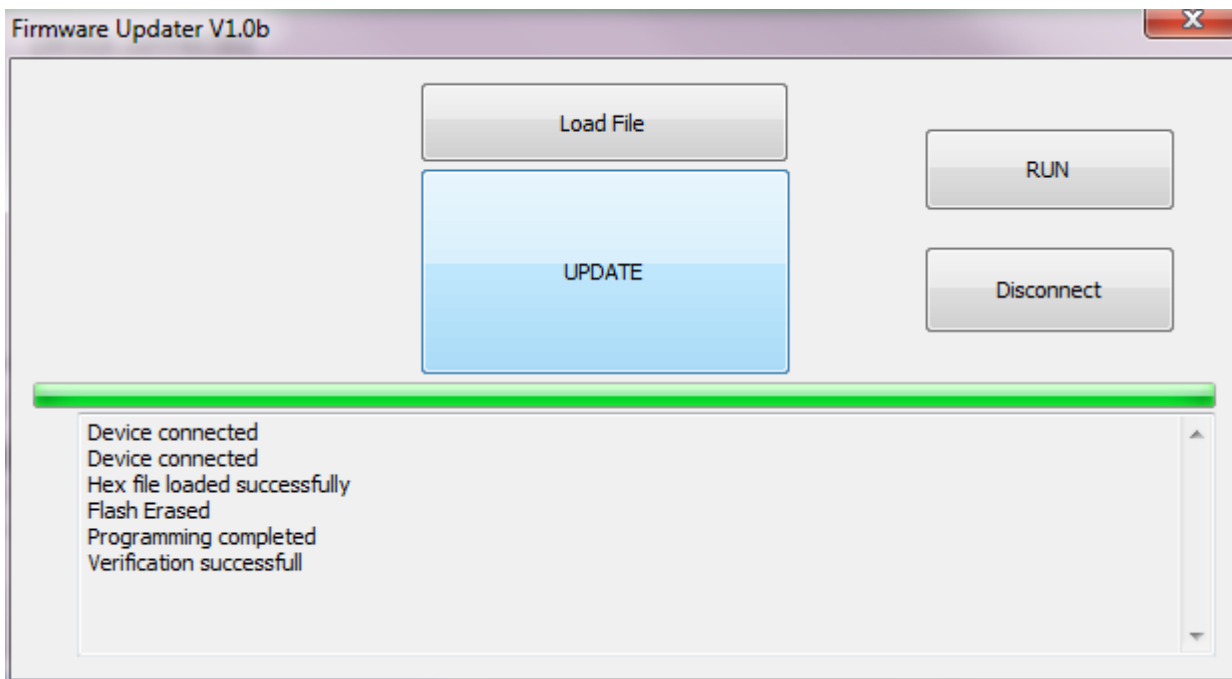

9. Press “RUN” or cycle power on your amp and the device will now run the new firmware version!

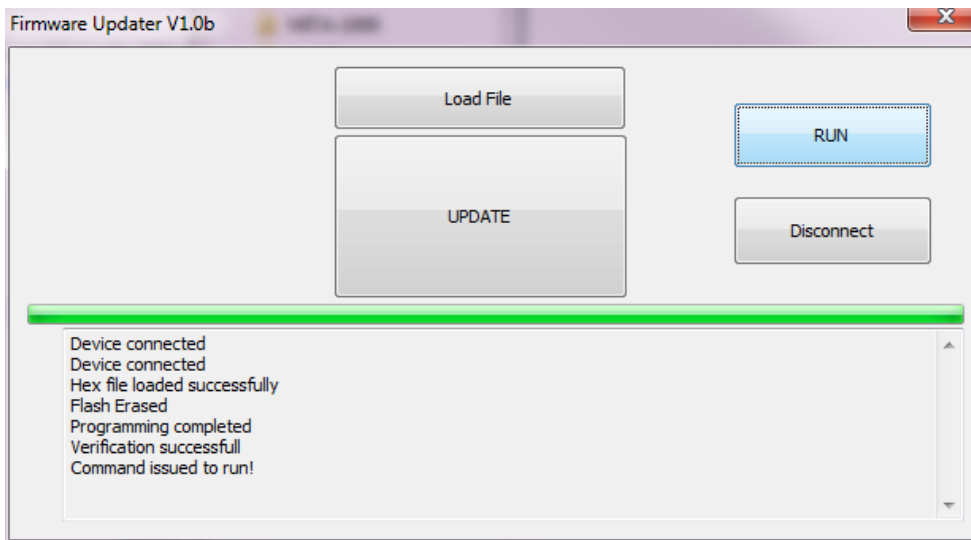

10. To validate your firmware was successfully updated you can note a new operating system version number “V.X.OX” on amp boot-up.



DSP Functions

Feature Controller (LCD matrix, single-knob, bezel mounted)

- a) **Volume:** Range: 0 ~ -100dB, Step: 1dB
- b) **High pass Filter:**
 - o **Frequency Select:** 31.5Hz ~ 125Hz, Step: 1 / 6 Oct. **Slope:** Flat/-12dB/-24dB
- A. Low pass Filter:**
 - a) **Frequency Range:** 31.5Hz ~125Hz, Step: 1 / 6 Oct.
 - b) **Slope:** Flat/-12dB/-24dB
 - c) **Variable Phase:** Range: 0° ~ -180°, Step: -5°
 - d) **High Pass Delay:** Delay Time Range: 0ms ~ 10ms, Step : 0.1ms
- B. Room Gain Comp (Deleted with room auto-EQ):**
 - a) Enable/Disable
 - b) **FREQ:** 25/31/40 Hz
 - c) **Slope:**-6/-12dB/Oct.
- C. Subwoofer tune mode:** Sealed/16Hz/20Hz/25Hz
- D. Three-band Parametric EQ**
 - a) **Frequency Range:** 31.5Hz ~125Hz, Step: 1/12 OCT
 - b) **Level Range:** +3dB ~-12dB, Step: 1dB
 - c) **Q Range:** 2.0 / 2.4 / 2.9 / 3.6 / 4.8 / 5.7 / 7.2 / 9.6 / 14.4
- E. Auto Room EQ (optional, incl. mic choice, dedicated ADI Sharc™ DSP, advanced program-ready)**
 - o 3 position acquisition. Each pos. calc. with 12 measurement, 5-band PEQ correction
- F. Input Source:**
 - o Analog or Digital audio source selection

Advanced Control (for GUI via USB port, PC or Mac)

- a) **Room auto-EQ GUI** gives post-correction spectrum display, EQ variance/specs
- b) **I/O level meter (0-99dB)**
- c) **Five-band Parametric EQ Settings**
 - o **EQ types:** Peaking, high shelving, low shelving, notch, HPF, LPF
 - o **Frequency range:** 20Hz ~200Hz, Step: 1Hz
 - o **Level range:** +12dB ~ -6dB, Step: 0.1dB **Q range:** 0.4 ~11, Step: 0.1
- d) **LIMITER**
 - o **Threshold:** -12~0 dB, Step: 0.1dB
 - o **Attack:** 0.1 ~100ms, Step: 0.1ms
 - o **Release:** 100~5000ms Step: 0.1ms

Base Specifications (AudioPrecision®)

Parameters	Test conditions	Typical value	
Input sensitivity	RCA IN 1200W/4ohms @230VAC	280mV	
	XLR IN 1200W/4ohms @230VAC	280mV	
	SPDIF IN 1200W/4ohms @230VAC	-10dBFS	
Gain	AMP output 80Hz @ 1W output	+48dB	
Input saturation level	RCA left or right 80Hz	>2V(Hi-Level IN)	
	XLR left or right 80Hz	>2V(Hi-Level IN)	
	SPDIF 80Hz	N/A	
Noise Level	volume=0dB (MAX) @22Hz-20kHz AES17	-61dBV (S/N Ratio 98dB)	
	volume=0dB (MAX)@A weighted	-65dBV (S/N Ratio 102dB)	
Output power (4Ω) Note: SPA2400 x 2	1% THD+N @ 80Hz 230VAC	1350W	
	1% THD+N @ 80Hz 115VAC	1300 W	
Auto ON/OFF Auto ON sensitivity Auto OFF time	RCA Left , 80Hz	3mV	
		15mins	
Time delay		2ms	
Power amplifier protection	A- Short-circuit and under load protection	A-Yes	
	B- Thermal protection	B-Yes	
	C-Power Supply Protection-OCP, OVP, Full Power Protection	C-Yes	
Power Consumption:	@230Vac/60Hz A- Standby mode @230Vac/60Hz B- ON mode @230Vac/60Hz C- 1/8 power @230Vac/60Hz D- Rated power @115Vac/60Hz A- Standby mode @115Vac/60Hz B- ON mode @115Vac/60Hz C- 1/8 power @115Vac/60Hz D- Rated power	SPA1200DSP	SPA2400DSP
		A- 1 W B- 18.5 W C- 217 W D- 1607 W A- 1.9 W B- 19.8 W C- 216 W D- 1624 W	A- 1 W B- 35 W C- 363 W D- 2819 W A- 3 W B- 39 W C- 395 W D- 2929 W

	SPA1200DSP	SPA2400DSP	Control Panel
Weight:	4lbs	7.4lbs	0.6lbs
Dimension:	10.75"H x 9.5" W x 2.875 D	15.5625"H x 9.5" W x 2.875 D	3.5"H x 5.75" W x 1.25 D

5-Year Limited Warranty
See daytonaudio.com for details



daytonaudio.com
tel + 937.743.8248
info@daytonaudio.com

705 Pleasant Valley Dr.
Springboro, OH 45066
USA



Dayton Audio®