

Dipol zur freien Aufstellung. Einsatz als Super- Hochtöner für vorhandene Lautsprecher oder Dipol- Breitbänder. 4 Ohm Version. Etwas tiefere Übernahmefrequenz.

- Keine Schallwand notwendig • Linear bis 35 kHz

Free-standing Dipole. Useable as a super tweeter for existing speaker boxes or for combination with full range drivers. 4 ohms version. Lower cross over frequency.

- No baffle required • Frequency range up to 35 kHz

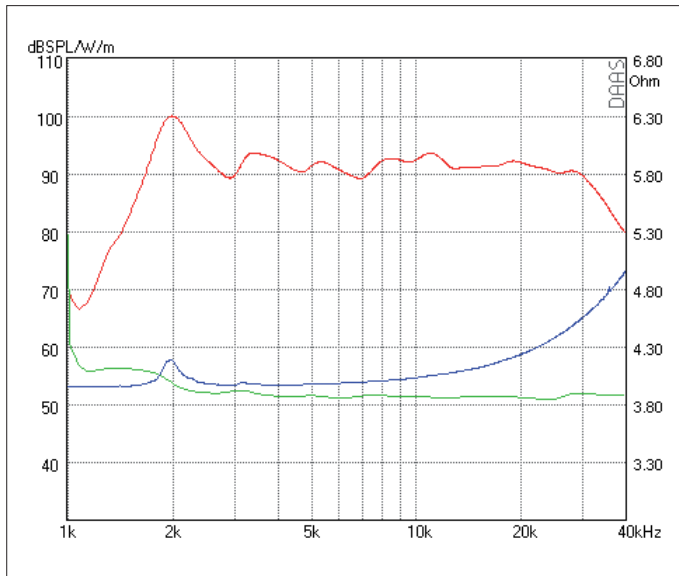

SPL 2.83 V - Phase - Impedance

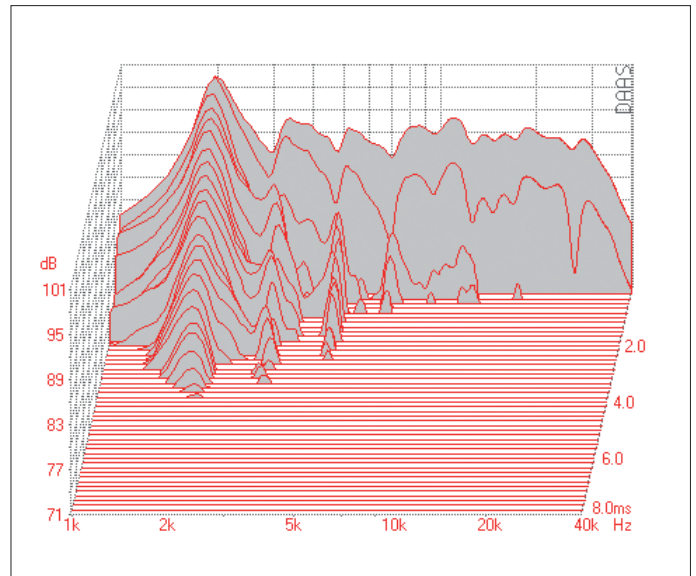

Waterfall

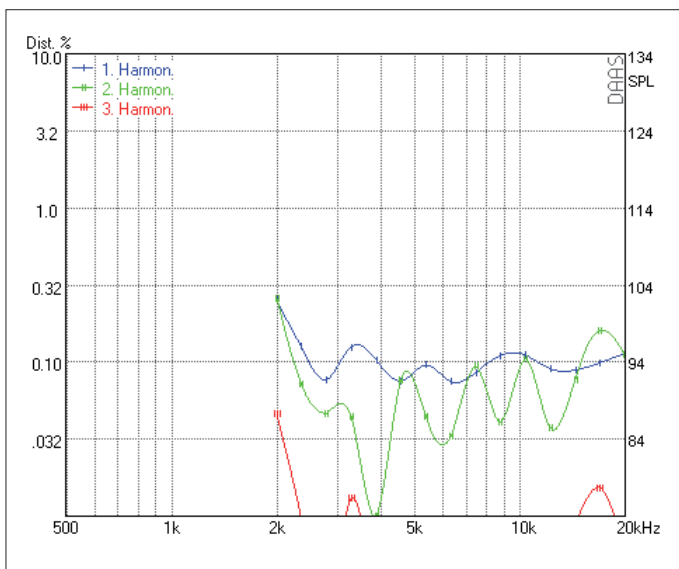

Harmonic Distortion 2.83 V

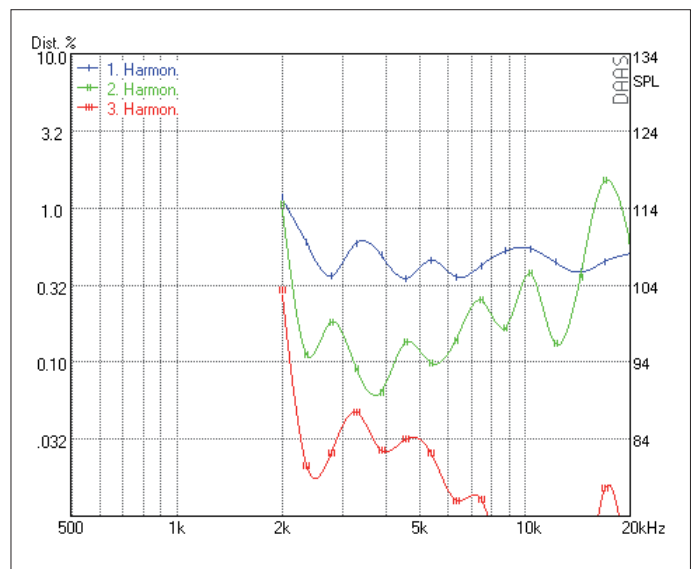

Harmonic Distortion 105 dB

RESISTANCE	NOMINAL 4 OHM			
Z ₀ 4.2 OHM	•	Z _{min} 3.9 OHM	•	RE 3.9 OHM
SENSITIVITY @ 2.83 V	91 dB			
FREQUENCY RESPONSE / -6 dB	1500 Hz - 35 kHz			
POWER HANDLING	60 W			
RESONANCE FREQUENCY / FS	2000 Hz			
RECOMMENDED CROSSOVER / 6 dB	5000 Hz			
RECOMMENDED CROSSOVER / 12 dB	4000 Hz			
DISPERSION HORIZONTAL / 15 kHz / -6 dB	50°			
DIAPHRAGM AREA	1260 mm ²			
MAGNET MATERIAL	NEODYMIUM			
FACE PLATE	non			

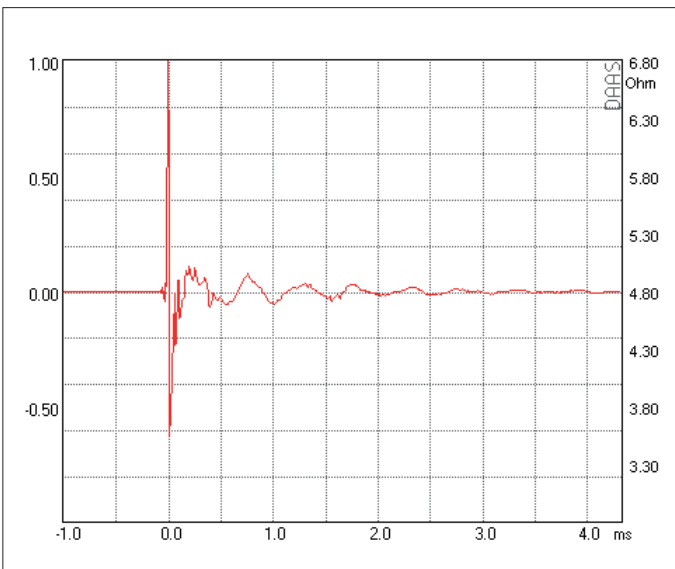
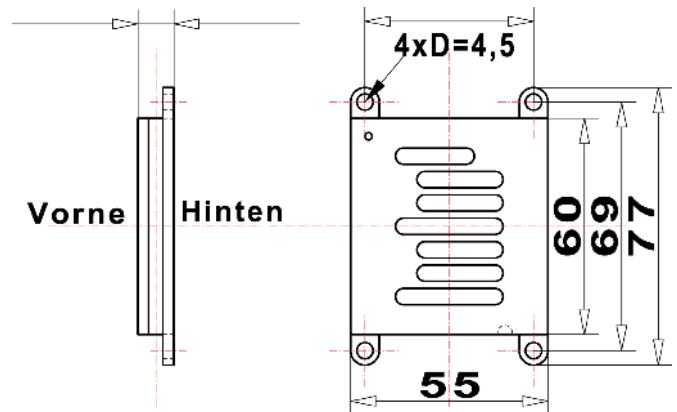

Impulse Response

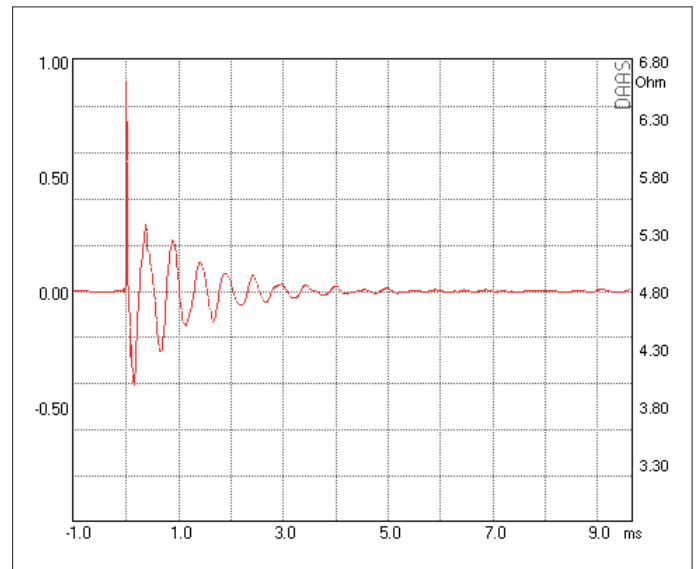

Step Response

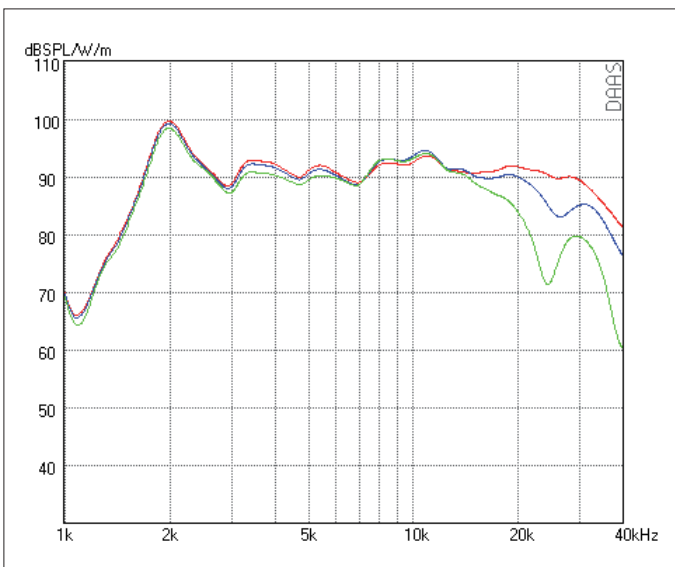

SPL HORIZONTAL 0° - 15° - 30°

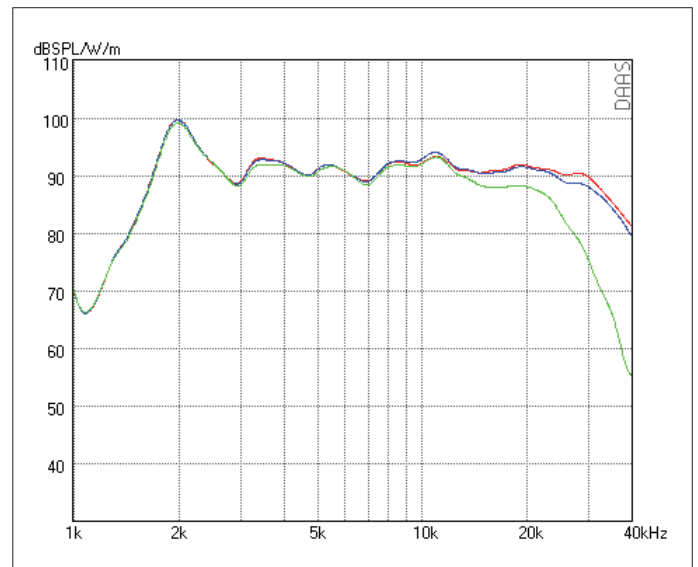

SPL VERTIKAL 0° - 5° - 15°