

# HiFi SERIE

**AMT25CS2.1-R**  
329 €/pc

### Special Properties

- High Efficiency
- High SPL-max
- Low Distortion

RESISTANCE	NOMINAL 8 OHM
Zo 7.9 OHM • Zmin 7.7 OHM • RE 7.6 OHM	
SENSITIVITY @ 2.83 V	96 dB
FREQUENCY RESPONSE / -6 dB	1600 Hz – 27 kHz
POWER HANDLING	230 W
RESONANCE FREQUENCY / FS	1100 Hz
RECOMMENDED CROSSOVER / 6 dB	2000 Hz
RECOMMENDED CROSSOVER / 12 dB	2000 Hz
DISPERSION HORIZONTAL / 15 kHz / -6 dB	60°
DIAPHRAGM AREA	6464 mm <sup>2</sup>
MAGNET MATERIAL	NEODYMIUM
FACE PLATE	3 mm Anodized Aluminum
TOTAL WEIGHT	650 g

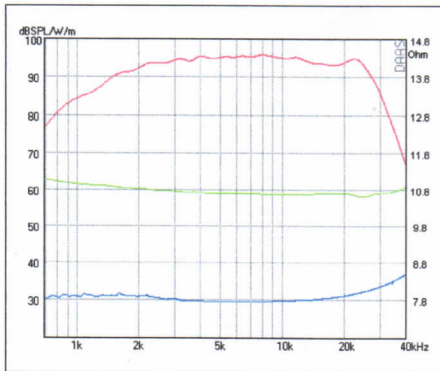

SPL 2.83 V - Phase - Impedance

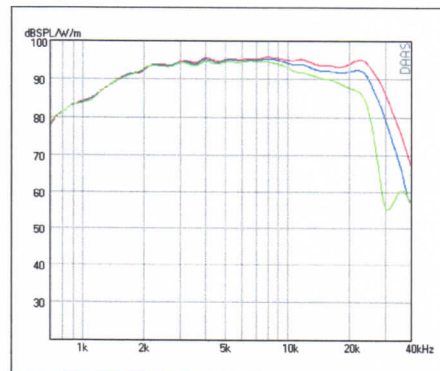

SPL HORIZONTAL 0° - 15° - 30°

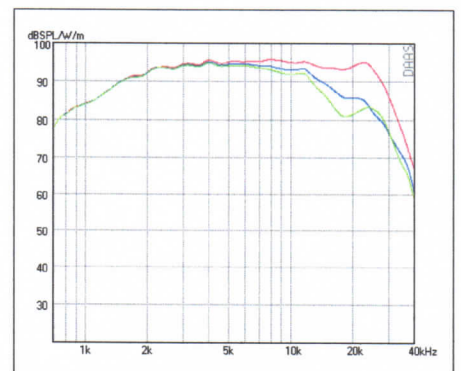

SPL VERTIKAL 0° - 5° - 15°

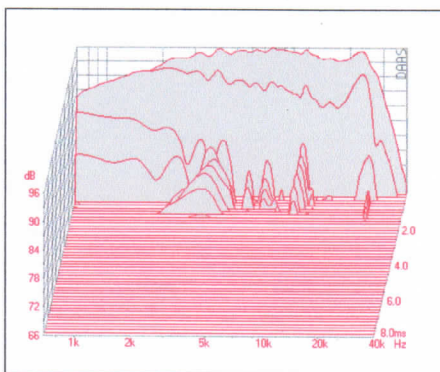

Waterfall

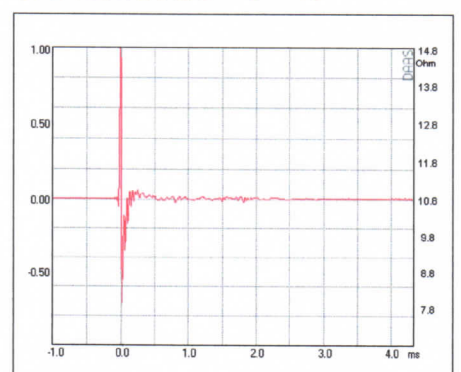
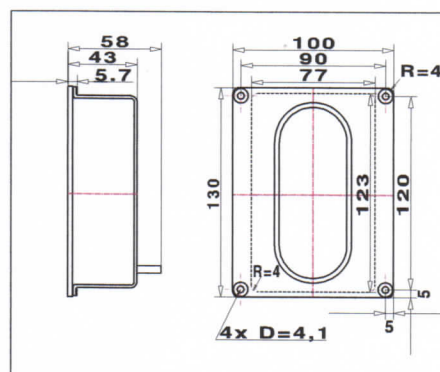

Impulse Response

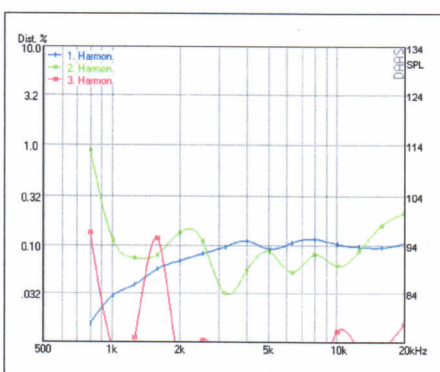

Harmonic Distortion 2.83 V

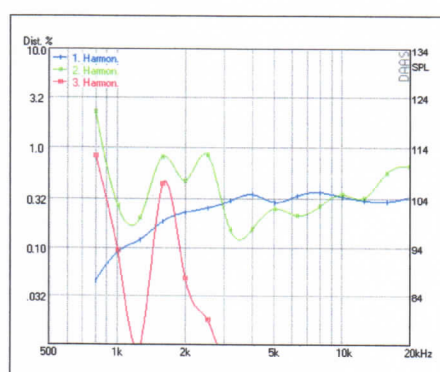

Harmonic Distortion 105 dB

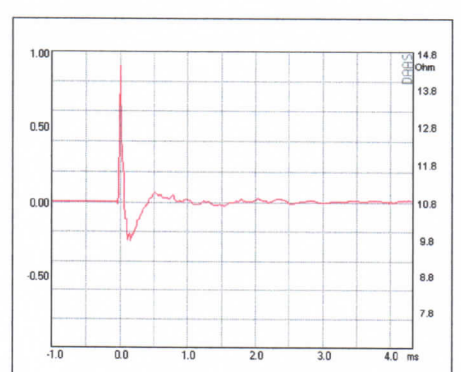

Step Response