

Schematics

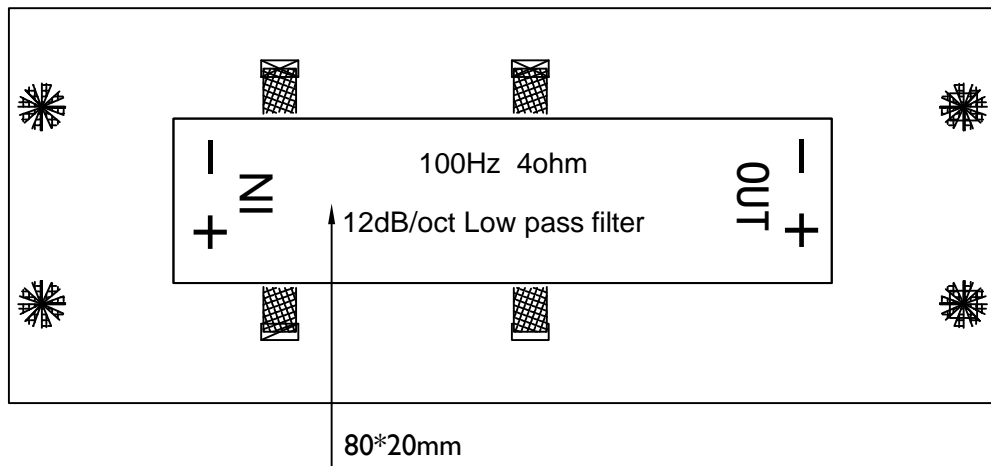
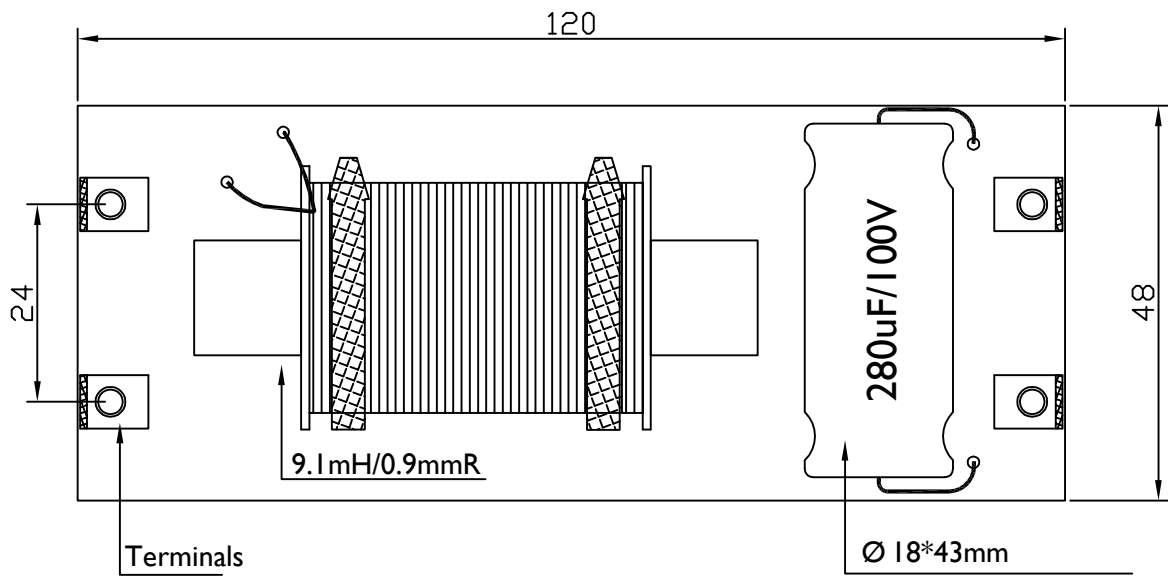
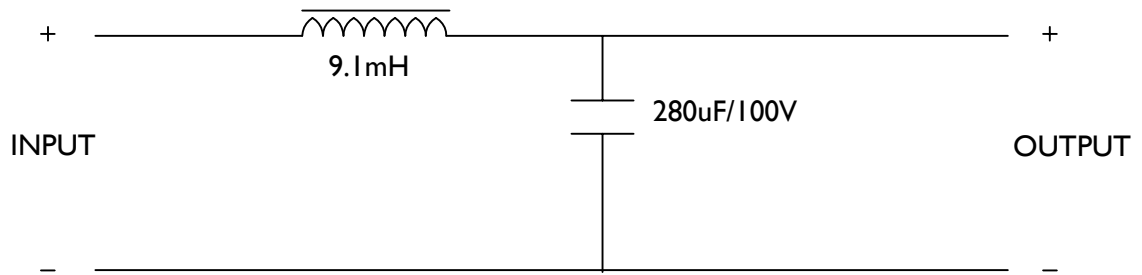

Drawn	Checked	Approved	REV	AI.1	Part no.	266-444
			Date	2013.10.14	Part name	CROSSOVER
youliam	Nick	Vidin	R&A Products: Inductor and Crossover			