

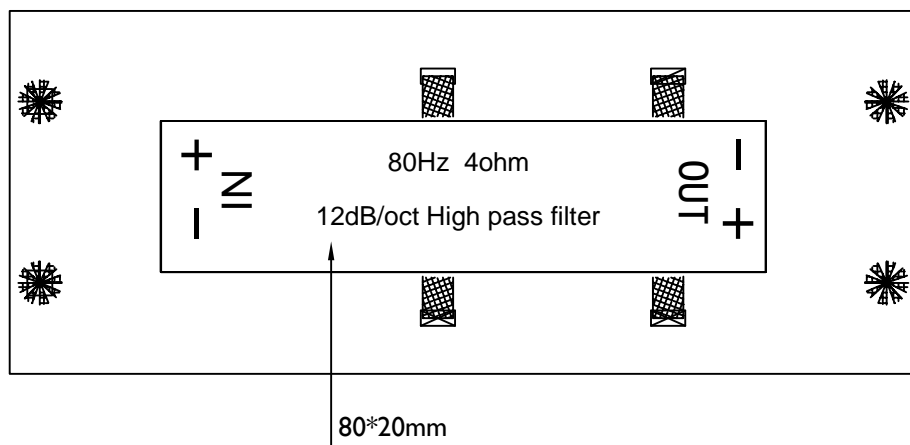

Schematics

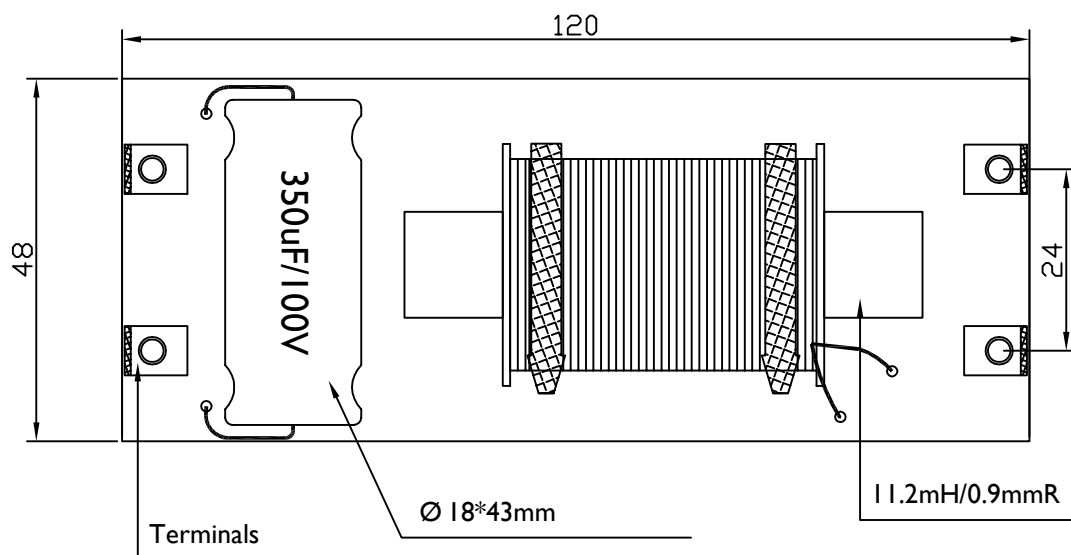
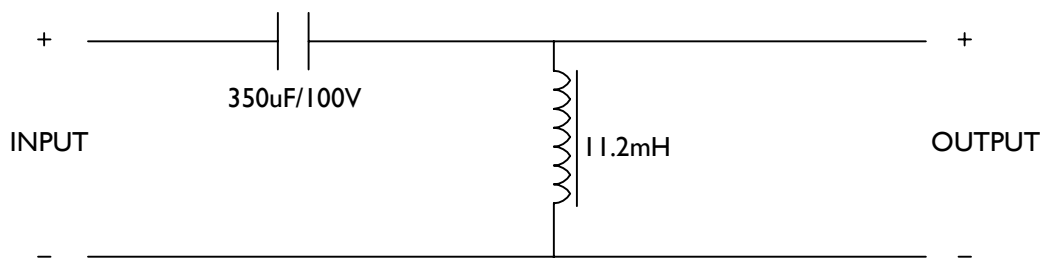

Drawn	Checked	Approved	REV	AI.1	Part no.	266-456
			Date	2013.10.14	Part name	CROSSOVER
youliam	Nick	Vidin	 Products: Inductor and Crossover			